

TARIFA 2026

ALMACÉN BARCELONA

V2.

VIGENTE A PARTIR
DEL 11 DE MAYO DE 2026

IRONLUX.COM



SERVICIO INTEGRAL

Trabajamos para ofrecerles el **mejor servicio** e incorporar nuevos productos con el fin de adaptarnos a sus necesidades y aumentar su negocio.



APOYO TÉCNICO - COMERCIAL

Disponemos de un completo equipo de **profesionales a su disposición** para solventar cualquier duda que les pueda surgir y, si es necesario, acompañarles en sus visitas a clientes.



PRESENCIA

Tenemos las puertas abiertas a nuestros clientes. Disponemos de **tres almacenes** con material en stock a los que podrán acudir para cualquier gestión. Además responderemos a cualquier cuestión posterior a la venta.



DISPONIBILIDAD

Ante cualquier problema encontrarán una **respuesta rápida y ayuda eficaz** por parte de nuestro equipo profesional.



MATERIAL DE SOPORTE

Disponibilidad de **vídeos técnicos de instalación** tanto en youtube como en nuestra web.



ALMACÉN IRONLUX GROUP 2003 S.A.



CÓMO LLEGAR



Horario:

Tienda y Atención al Cliente

De lunes a jueves de 7 a 17.30h.

Viernes de 7 a 15h.

Almacén y pedidos

De lunes a jueves de 7 a 13.30h y de 15 a 17.30h.

Viernes de 7 a 15h.



SOLICITUD DE PRESUPUESTOS
ofertas@ironlux.com

SOLICITUD PEDIDOS
pedidos@ironlux.com

TRANSPORTE (PRECIOS SUJETOS A DÍAS DE RUTA)

	ZONA 1	ZONA 2	ZONA 3	ZONA 4
Pedidos hasta 1.500€	100€	130€	170€	200€
Pedidos > 1.500€	80€	105€	135€	160€

ZONAS



CONDICIONES GENERALES Y PORTES IRONLUX GROUP

- Material entregado en destino (longitud máxima 8 metros)
- Para longitudes superiores a 8 metros y zonas de difícil acceso para nuestro camión, consultar precio del vehículo adecuado.
- Los precios **no incluyen descarga con camión grúa**.
- **Las entregas se harán durante el día**. No podemos garantizar horarios de entrega.



**MEDIOS DE DESCARGA
A CARGO DEL CLIENTE**

CLICA EL CÓDIGO PARA IR A LOS VIDEOS EXPLICATIVOS

 **YouTube**

LUCERNARIOS



PANEL CUBIERTA
ESTANDAR



PANELES
ESPECIALES
CUBIERTA



PANELES
FACHADA



REMATES



 **YouTube**

SUSCRÍBETE
A NUESTRO
CANAL



ZONAS
COMERCIALES
POR ALMACENES



CONDICIONES
GENERALES
DE VENTA





CERRAMIENTOS

ALMACÉN BARCELONA

IRONLUX.COM





INFORMACIÓN IMPORTANTE PARA NUESTROS CLIENTES

DEBIDO A LOS CONTINUOS CAMBIOS EN
LOS COSTES DE LAS MATERIAS PRIMAS
POR LA INESTABILIDAD DEL MERCADO,
**NUESTROS PRECIOS* PUEDEN SUFRIR
ALTERACIONES.**

Informaremos de las actualizaciones vía
correo electrónico así como en nuestra WEB
www.ironlux.com

RECOMENDAMOS
REVISAR
LA VIGENCIA
DE LOS PRECIOS
A TRAVÉS
DE NUESTRA WEB.



TARIFA
ACTUALIZADA

*Los datos técnicos y precios serán válidos a partir
de la publicación de esta tarifa **salvo cambios en
el mercado o error tipográfico.**

CUBIERTA ESTÁNDAR Y ACCESORIOS



PANEL CUBIERTA ESTÁNDAR
ACCESORIOS CUBIERTA

PRECIOS SIN IVA

SERVICIOS

* PRECIOS NETOS 

DESPIECE Y CORTE
TRANSVERSAL
GRATUITOS

DISPONIBILIDAD
DE MUESTRAS
GRATUITAS

CORTE
LONGITUDINAL
20,00 €/ud.*

CORTE: 3000mm MÁXIMO

CORTE PARA
FACILITAR SOLAPE
10,00 €/ud.*

CORTE Y VACIADO
PARA SOLAPE
20,00 €/ud.*

MÁXIMO: 6000mm

TEJA
Y PIZARRA
30,00 €/ud.*

CONSULTAR DISPONIBILIDAD / PLAZOS



CUBIERTA ESTÁNDAR

GMPANEL TAPAJUNTAS (30) - BLANCO PIRINEO / BLANCO PIRINEO (SIMILAR, RAL 9003)

CÓDIGO: 0001

STOCK

LONGITUDES	2000 - 2500 - 3000 - 3500 - 4000 - 5000 - 6000 - 7000 - 8000 mm	ANCHO ÚTIL	1000 mm		
 Cs3d0			ESPESOR	PRECIO €/M ²	FICHA TÉCNICA 
 7,40 Kg/m ²			30 mm	32,30	
100 kg					
2250 mm. máx.					
K(W/m ² K)= 0,73	INTERIOR PERFILADO ESTÁNDAR				

GMPANEL TAPAJUNTAS (30) - ROJO TEJA 7001 (SIMILAR, RAL 3009) / BLANCO PIRINEO

CÓDIGO: 0002





STOCK

LONGITUDES	2000 - 2500 - 3000 - 3500 - 4000 - 5000 - 6000 - 7000 - 8000 mm	ANCHO ÚTIL	1000 mm		
 Bs2d0			ESPESOR	PRECIO €/M ²	FICHA TÉCNICA 
 7,40 Kg/m ²			30 mm	35,20	
110 kg					
2250 mm. máx.					
K(W/m ² K)= 0,73	INTERIOR PERFILADO ESTÁNDAR				

GMPANEL TAPAJUNTAS (30) - GRIS (RAL 7016) / BLANCO PIRINEO

CÓDIGO: 0003

STOCK

LONGITUDES	2000 - 2500 - 3000 - 3500 - 4000 - 5000 - 6000 - 7000 mm	ANCHO ÚTIL	1000 mm		
 Bs2d0			ESPESOR	PRECIO €/M ²	FICHA TÉCNICA 
 8,60 Kg/m ²			30 mm	41,75	
100 kg					
2500 mm. máx.					
K(W/m ² K)= 0,73	INTERIOR PERFILADO ESTÁNDAR				

CUBIERTA ESTÁNDAR

GMPANEL TAPAJUNTAS (30) - VERDE NAVARRA (SIMILAR, RAL 6005) / BLANCO PIRINEO

CÓDIGO: 0123

STOCK

LONGITUDES	3000 - 4500 - 6000 - 9000 mm	ANCHO ÚTIL	1000 mm		
 Bs2d0			ESPESOR	PRECIO €/M ²	FICHA TÉCNICA 
 7,40 Kg/m ²			30 mm	35,20	
100 kg					
2250 mm. máx.					
K(W/m ² K)= 0,73	INTERIOR PERFILADO ESTÁNDAR				

GMPANEL TAPAJUNTAS (40) - BLANCO PIRINEO / BLANCO PIRINEO (SIMILAR, RAL 9003)

CÓDIGO: 0058

STOCK

LONGITUDES	2500 - 3000 - 3500 - 4000 - 5000 - 6000 - 7000 - 8000 mm	ANCHO ÚTIL	1000 mm		
 Bs2d0			ESPESOR	PRECIO €/M ²	FICHA TÉCNICA 
 10,90 Kg/m ²			40 mm	39,15	
109 kg					
3250 mm. máx.					
K(W/m ² K)= 0,51	INTERIOR PERFILADO ESTÁNDAR				

GMPANEL TAPAJUNTAS (50) ESPUMA PIR - B. PIRINEO / BLANCO PIRINEO (SIMILAR, RAL 9003)

CÓDIGO: 0055B

STOCK

LONGITUDES	2500 - 3000 - 3500 - 4000 - 5000 - 6000 - 7000 mm	ANCHO ÚTIL	1000 mm		
 Bs1d0			ESPESOR	PRECIO €/M ²	FICHA TÉCNICA 
 8,20 Kg/m ²			50 mm	43,75	
105 kg					
2750 mm. máx.					
K(W/m ² K)= 0,45	INTERIOR PERFILADO ESTÁNDAR				

CUBIERTA ESTÁNDAR





GMPANEL TAPAJUNTAS 2G (80) - BLANCO PIRINEO / BLANCO PIRINEO (SIMILAR, RAL 9003)

CÓDIGO: 0056

STOCK

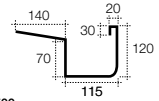
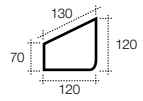
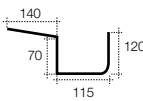







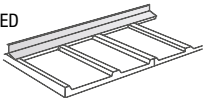
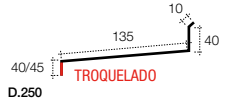
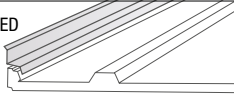
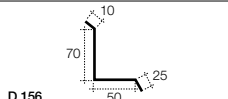

LONGITUDES	2500 - 3000 - 3500 - 5000 - 6000 - 7000 mm	ANCHO ÚTIL	1000 mm		
 Bs2d0		CE	ESPESOR	PRECIO €/M ²	FICHA TÉCNICA 
 11,55 Kg/m ²			80mm	52,90	
110 kg 4000 mm. máx.					
K(W/m ² K)= 0,27					
INTERIOR PERFILADO EN LAMAS					

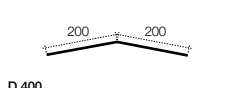
ACCESORIOS REMATERÍA ESTÁNDAR CUBIERTA

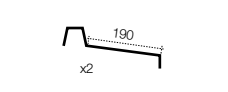
		ESPESOR (mm.)	COLOR	LONGITUD (mm.)	PRECIO €/UD						
CANALES	Remate Canalón		0,6	BLANCO PIRINEO	3.000	47,50					
	Remate Tapa Canalón		0,6	BLANCO PIRINEO	PAREJA	28,55					
	Remate Collarín Canalón		0,6	BLANCO PIRINEO	UNIDAD	9,05					
	UNIÓN CANALÓN										
	BLANCO PIRINEO	€/UD		BLANCO PIRINEO	€/UD		BLANCO PIRINEO	€/UD		BLANCO PIRINEO	€/UD
TUBO 75Ø 1000mm	14,45		CODO 45° EXTENSIÓN 400mm	29,20		CODOS 45° / 90°	15,45		ABRAZADERA	3,20	

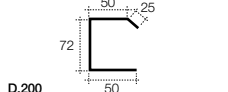
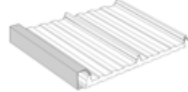
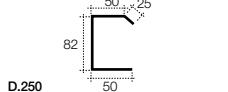
BOCA BAJANTE 75Ø: 8,90 €/UD

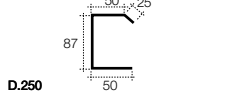
CUBIERTA ESTÁNDAR

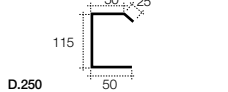
ACCESORIOS REMATERÍA ESTÁNDAR CUBIERTA				ESPESOR (mm.)	COLOR	LONGITUD (mm.)	PRECIO €/UD
ENTREGAS	Remate Trasera troquelada TPJ	PARED 		0,6	BLANCO PIRINEO ROJO TEJA RAL 7016 VERDE NAVARRA	2.100	22,95
	Remate Entrega Lateral a pared	PARED 		0,6	BLANCO PIRINEO ROJO TEJA RAL 7016 VERDE NAVARRA	1.500 3.000	8,20 16,40
CUMBRERAS	Remate Cumbre Simple			0,6	BLANCO PIRINEO	1.500 3.000	19,55 39,10
	Remate Cumbre Troquelada			0,6	BLANCO PIRINEO ROJO TEJA RAL 7016 VERDE NAVARRA	2.100	44,85
LATERALES	Remate Lateral 30			0,6	BLANCO PIRINEO ROJO TEJA RAL 7016 VERDE NAVARRA	1.500 3.000	10,15 20,30
	Remate Lateral 40			0,6	BLANCO PIRINEO	1.500 3.000	11,95 23,90
	Remate Lateral 50			0,6	BLANCO PIRINEO	1.500 3.000	11,95 23,90
	Remate Lateral 80			0,6	BLANCO PIRINEO	1.500 3.000	11,95 23,90

CUBIERTA ESTÁNDAR

ACCESORIOS REMATERÍA ESTÁNDAR CUBIERTA				ESPESOR (mm.)	COLOR	LONGITUD (mm.)	PRECIO €/UD
FRONTALES	Remate Frontal/Trasero Simple 30			0,6	BLANCO PIRINEO ROJO TEJA RAL 7016	1.500 3.000	10,15 20,30
	Remate Frontal/Trasero Simple 40/50			0,6	BLANCO PIRINEO	1.500 3.000	10,15 20,30
	Remate Frontal/Trasero Simple 80			0,6	BLANCO PIRINEO	1.500 3.000	11,95 23,90
	Remate Tapa Frontal 30/40/50/80			0,6	B.P. (30/40/50/80) ROJO TEJA (30) RAL 7016 (30) VERDE NAV. (30)	1.000	9,20

REMATERÍA A MEDIDA

CÓDIGO: 0039

€/ml	REMATES DE ACERO GALVANIZADO										
Esp./Desarrollo (mm.)*	125	156	200	250	333	400	500	625	750	1.000	1.250
0,60	4,20	4,70	5,90	7,10	7,80	10,10	11,80	14,10	16,40	20,60	25,10
0,80	5,20	5,60	7,30	8,60	9,60	12,40	14,60	17,40	20,50	26,10	31,90
1,00	6,00	6,50	8,70	9,80	12,10	14,60	17,30	21,00	24,20	31,60	38,60
1,20	6,90	7,70	9,80	11,90	14,50	17,80	20,50	25,30	30,10	39,10	47,90
1,50	8,20	10,10	12,60	14,60	17,10	21,30	27,80	34,70	41,70	55,20	68,70
€/ml	REMATES DE ACERO PRELACADO										
0,60	4,80	5,20	6,80	8,00	8,80	11,50	13,50	17,90	19,70	25,00	30,90
0,80	7,10	7,60	11,60	12,40	15,00	17,40	19,80	23,80	26,30	33,30	41,30
Troquelados Std	***	***	***	10,30	14,50	16,05	17,45	21,15	***	***	***

BAJO PEDIDO A MEDIDA * Desarrollo: Suma de las cotas en milímetros

CHAPA LISA DE ACERO		€/m ²	€/UD
CHAPA LISA BLANCO PIRINEO		3.000 x 1.250 x 0,6	20,80 78,00

STOCK

1

ORIENTACIÓN DE LA PLACA

Los nervios deben ir, siempre, en la dirección de la pendiente.

(Para facilitar la evacuación del agua)

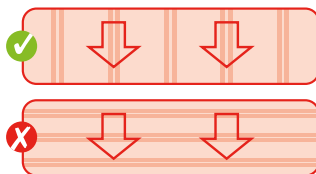

PENDIENTE MÍNIMA

Panel TAPAJUNTAS **5%**

Panel TEJA **10%**

Tornillería Vista **7%**

Panel PIZARRA **30%**

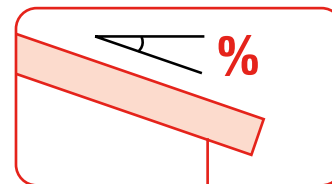

2

3

Tener en cuenta el encaje inferior del panel a la hora de planificar el lado de inicio del montaje.

1°.- Fijar la pieza con el tetón inferior.

2°.- Ajustar la placa con el "encaje" y fijarla.

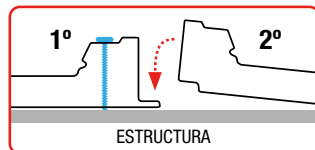

PERIMETRAL

Conviene "sanear" los cantos de la chapa de posibles rebabas adheridas (derivadas del corte). Eliminar también las de la superficie de la placa. Evitaremos así manchas por óxido y posibles rayadas al pisarlas. También es recomendable tapar las zonas de espuma vista para mejorar el aspecto general de la instalación y evitar la entrada de insectos como abejas o avispas.

4

5

FIJACIONES

Las fijaciones deberán situarse siempre en la parte alta de la junta. Evitar, en la medida de lo posible, perforar en el "paso de agua".

Es un sistema de Tornillería Oculta.

Una vez fijado con los tornillos, **instalar** la TAPETA a presión (incluida en el panel).

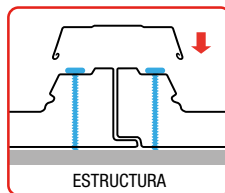

Una vez finalizada la instalación, no demorar demasiado la retirada del film de protección.

La acción del sol podría complicarla.

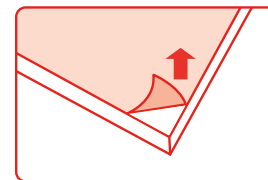

6

TEJA / PIZARRA Y ACCESORIOS

PANEL CUBIERTA TEJA
PANEL CUBIERTA PIZARRA
ACCESORIOS

PRECIOS SIN IVA

SERVICIOS

* PRECIOS NETOS 

DESPIECE Y CORTE
TRANSVERSAL
GRATUITOS

DISPONIBILIDAD
DE MUESTRAS
GRATUITAS

CORTE
LONGITUDINAL
20,00 €/ud.*

CORTE: 3000mm MÁXIMO

CORTE PARA
FACILITAR SOLAPE
10,00 €/ud.*

CORTE Y VACIADO
PARA SOLAPE
20,00 €/ud.*

MÁXIMO: 6000mm

TEJA
Y PIZARRA
30,00 €/ud.*

CONSULTAR DISPONIBILIDAD / PLAZOS



CUBIERTA TEJA

GMPANEL TEJA - **LAMAS** - RAL 8004 / BLANCO PIRINEO

CÓDIGO: 0060

STOCK

LONGITUDES

1750 - 2100 - 2450 - 2800 - 3500 - 4200 - 4900 - 5600 - 6650 - 7700 mm

ANCHO ÚTIL

1000 mm

 **Bs2d0**

 9,20 Kg/m²

95 kg
1750 mm. máx.

K(W/m²K)= 0,40

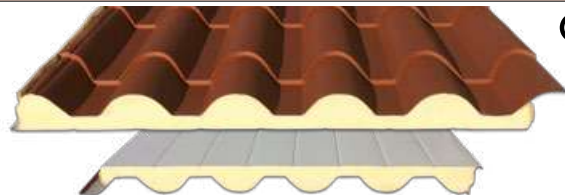

CE

ESPESOR

55mm*

* PROMEDIO

PRECIO €/M²

54,40

FICHA TÉCNICA



INTERIOR PERFILADO EN LAMAS

GMPANEL TEJA - **LAMAS** - RAL 8004 / IMITACIÓN MADERA OSCURA

CÓDIGO: 0061

STOCK

LONGITUDES

1750 - 2450 - 3500 - 4900 - 5950 mm (OTRAS MEDIDAS, CONSULTAR)

ANCHO ÚTIL

1000 mm

 **Bs2d0**

 9,20 Kg/m²

95 kg
1750 mm. máx.

K(W/m²K)= 0,40

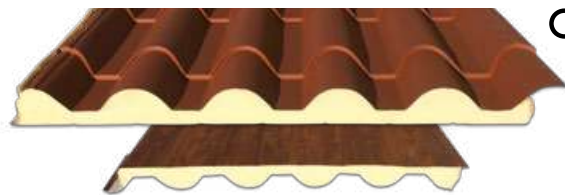

CE

ESPESOR

55mm*

* PROMEDIO

PRECIO €/M²

63,10

FICHA TÉCNICA



INTERIOR PERFILADO EN LAMAS

GMPANEL TEJA - **LAMAS** - GRIS (SIMILAR, RAL 7024) / BLANCO PIRINEO

CÓDIGO: 0066

STOCK

LONGITUDES

1750 - 2450 - 3500 - 4900 - 5950 mm

ANCHO ÚTIL

1000 mm

 **Bs2d0**

 9,20 Kg/m²

95 kg
1750 mm. máx.

K(W/m²K)= 0,40

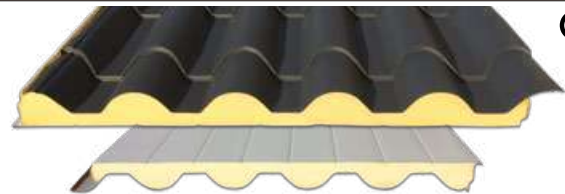

CE

ESPESOR

55mm*

* PROMEDIO

PRECIO €/M²

58,40

FICHA TÉCNICA







INTERIOR PERFILADO EN LAMAS

CUBIERTA TEJA

GMPANEL TEJA - LAMAS - ALBERO ENVEJECIDO / BLANCO PIRINEO

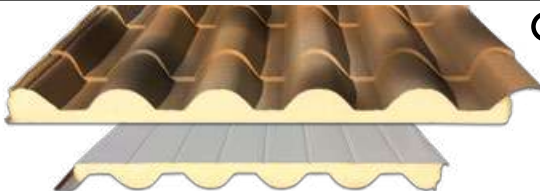
CÓDIGO: 0062

STOCK

LONGITUDES	1750 - 2450 - 3500 - 4900 - 5950 mm (OTRAS MEDIDAS, CONSULTAR)	ANCHO ÚTIL	1000 mm		
 Bs2d0		ESPESOR	PRECIO €/M ²		
 9,20 Kg/m ²			55mm* * PROMEDIO	59,90	
95 kg					FICHA TÉCNICA 
1750 mm. máx.					
K(W/m ² K)= 0,40	INTERIOR PERFILADO EN LAMAS				

GMPANEL TEJA - LAMAS - ALBERO ENVEJECIDO / IMITACIÓN MADERA OSCURA

CÓDIGO: 0063

STOCK

LONGITUDES	1750 - 2450 - 3500 - 4900 - 5950 mm (OTRAS MEDIDAS, CONSULTAR)	ANCHO ÚTIL	1000 mm		
 Bs2d0		ESPESOR	PRECIO €/M ²		
 9,20 Kg/m ²			55mm* * PROMEDIO	69,75	
95 kg					FICHA TÉCNICA 
1750 mm. máx.					
K(W/m ² K)= 0,40	INTERIOR PERFILADO EN LAMAS				

ACABADO INFERIOR EN LAMAS
(residencial)

Clasificación fuego: **Bs2d0**

Interior: Acero, imitación LAMAS

OPCIONES: IMITACIÓN MADERA o BLANCO PIRINEO



CUBIERTA TEJA

GMPANEL TEJA - ECOTEJA - RAL 8004 / BLANCO PIRINEO

CÓDIGO: 0067

STOCK

LONGITUDES 2100 - 2450 - 3500 - 4200 - 4900 mm (OTRAS MEDIDAS, CONSULTAR)

ANCHO ÚTIL 1000 mm

Kg 9,10 Kg/m²

110 kg
2700 mm. máx.

K(W/m²K)= 0,40

INTERIOR PERFILADO ESTÁNDAR

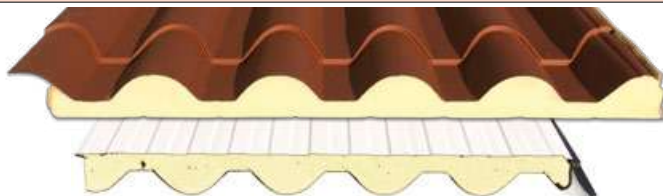

CE

ESPESOR

PRECIO €/M²

55mm*

* PROMEDIO

46,80

GMPANEL TEJA - ECOTEJA - ALBERO ENVEJECIDO / BLANCO PIRINEO

CÓDIGO: 0155

STOCK

LONGITUDES 2100 - 2450 - 3500 - 4200 - 4900 mm (OTRAS MEDIDAS, CONSULTAR)

ANCHO ÚTIL 1000 mm

Kg 9,10 Kg/m²

110 kg
2700 mm. máx.

K(W/m²K)= 0,40

INTERIOR PERFILADO ESTÁNDAR



CE

ESPESOR

PRECIO €/M²

55mm*

* PROMEDIO

50,70

ACABADO INFERIOR DOGATO
(perfilado estándar)

Clasificación fuego: **Tipo F**

Interior: Acero, perfil estándar

OPCIONES: BLANCO PIRINEO



CUBIERTA PIZARRA

GMPANEL PIZARRA - LAMAS - IMITACIÓN PIZARRA (SIMILAR, RAL 7024) - BLANCO PIRINEO

CÓDIGO: 0118

STOCK

LONGITUDES

3200 - 4000 - 6400 - 8000 mm

ANCHO ÚTIL

1000 mm

 Bs2d0

 9,20 Kg/m²

90 kg
3000 mm. máx.

K(W/m²K)= 0,38



CE

ESPESOR

60mm

PRECIO €/M²

81,45

INTERIOR PERFILADO EN LAMAS / CUBIERTA O FACHADA - INSTALACIÓN HORIZONTAL (ANCHO = ALTURA)

SECCIÓN TÉCNICA PANEL

*Cotas interiores

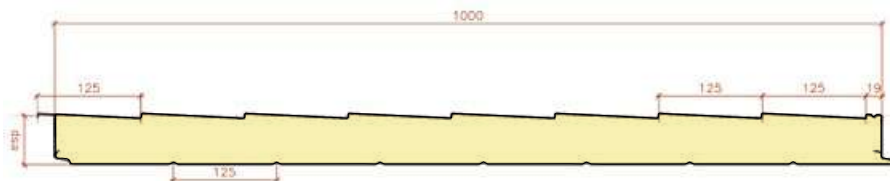

MONTAJE

PRESENTACIÓN DE ENCAJE

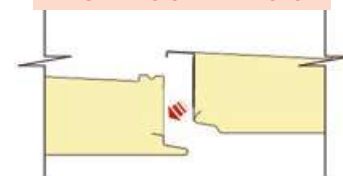

INSTALACIÓN HORIZONTAL



ENCAJE FINAL DEL PANEL

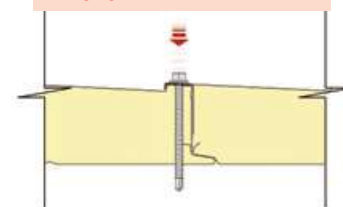



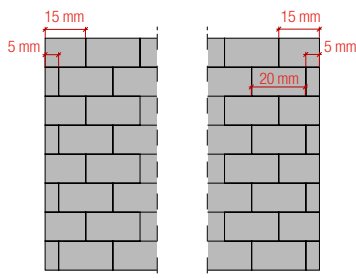

CUBIERTA TEJA

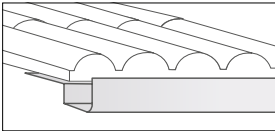
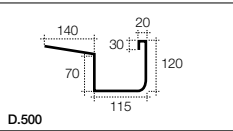
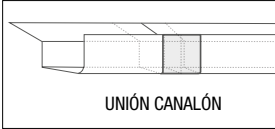
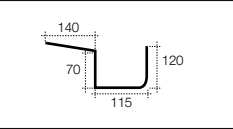
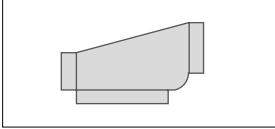
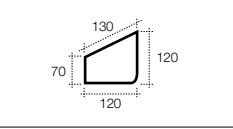

Medidas de las tejas en los extremos del panel.

Cantidad de tejas a lo ancho: 8

ACCESORIOS REMATERÍA PANEL TEJA

ACCESORIOS REMATERÍA PANEL TEJA				ESPESOR (mm.)	COLOR	LONGITUD (mm.)	PRECIO €/UD			
CAVALES	Remate Canalón Teja		 D.500	0,6	RAL 8004 ALBERO ENVEJECIDO GRIS 7024	3.000	59,20			
	Remate Collarín de unión canalón Teja	 UNIÓN CANALÓN		0,6	RAL 8004 ALBERO ENVEJECIDO GRIS 7024	UNIDAD	9,05			
	Remate Tapa Canalón Teja			0,6	RAL 8004 ALBERO ENVEJECIDO GRIS 7024	PAREJA	30,20			
	RAL 8004 RAL 7024 RAL 1001	€/UD		RAL 8004 RAL 7024 RAL 1001	€/UD		RAL 8004 RAL 7024 RAL 1001	€/UD		€/UD
TUBO 75Ø 1000mm	14,45	CODO 45° EXTENSIÓN 400mm	29,20	CODOS 45° / 90°	15,45	ABRAZADERA	3,20			

BOCA BAJANTE 75Ø: 8,90 €/UD

CUBIERTA TEJA

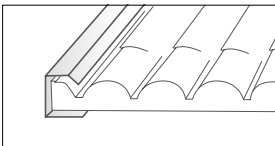
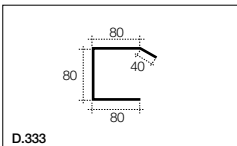
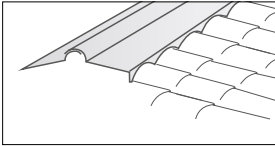
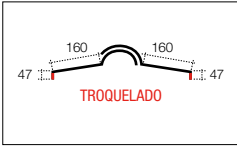
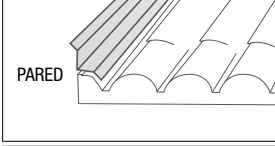
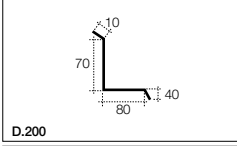
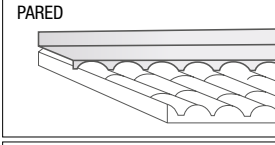
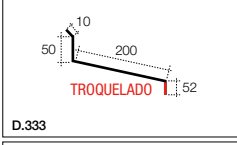
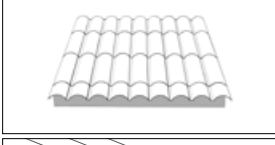
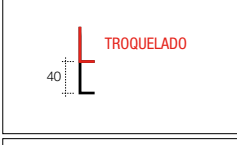
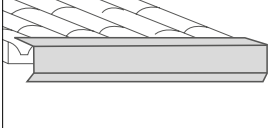
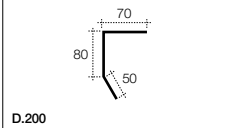
ACCESORIOS REMATERÍA PANEL TEJA				ESPESOR (mm.)	COLOR	LONGITUD (mm.)	PRECIO €/UD
LATERALES	Remate Lateral Teja		 D.333	0,6	RAL 8004 ALBERO ENVEJECIDO GRIS 7024	1.500	19,25
						3.000	38,50
CUMBRERAS	Remate Cumbre Troquelada Teja			0,6	RAL 8004 ALBERO ENVEJECIDO GRIS 7024	2.060	73,50
ENTREGAS	Remate Entrega Lateral a pared Teja		 D.200	0,6	RAL 8004 ALBERO ENVEJECIDO GRIS 7024	1.500	14,80
						3.000	29,60
FRONTALES	Remate Pared Trasera Troquelada Teja		 D.333	0,6	RAL 8004 ALBERO ENVEJECIDO GRIS 7024	2.060	33,35
FRONTALES	Remate Tapa Frontal Teja			0,6	RAL 8004 ALBERO ENVEJECIDO GRIS 7024	1.000	10,80
FRONTALES	Remate Frontal/Trasero Simple Teja		 D.200	0,6	RAL 8004 ALBERO ENVEJECIDO GRIS 7024	1.500	14,80
						3.000	29,60

CUBIERTA TEJA

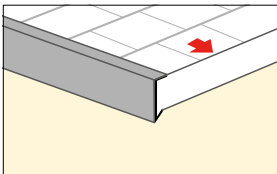
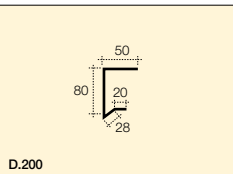
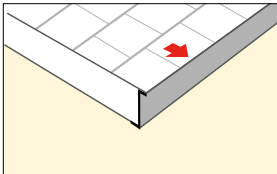
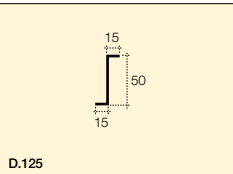
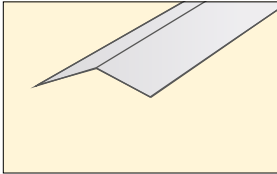
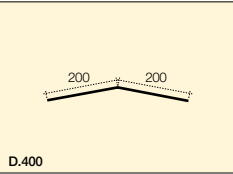
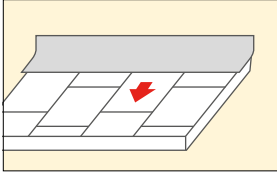
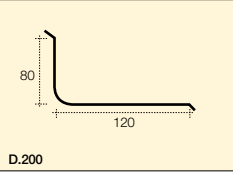
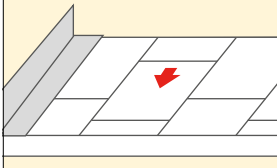
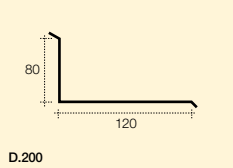
ACCESORIOS REMATERÍA PANEL PIZARRA				ESPESOR (mm.)	COLOR	LONGITUD (mm.)	PRECIO €/UD
PIZARRA	Remate Lateral Pizarra			0,6	GRIS 7024	1.500	16,70
						3.000	33,40
	Remate Frontal Pizarra			0,6	GRIS 7024	1.500	10,90
						3.000	21,80
	Remate Cumbre Simple Pizarra			0,6	GRIS 7024	1.500	23,55
						3.000	47,10
	Remate Entrega Trasera Pizarra			0,6	GRIS 7024	1.500	20,30
						3.000	40,60
	Remate Entrega Lateral Pizarra			0,6	GRIS 7024	1.500	16,70
						3.000	33,40

€/ml	REMATES DE ACERO PRELACADO										
Esp. Desarrollo (mm.)*	125	156	200	250	333	400	500	625	750	1.000	1.250
Troquelados - Teja	***	***	***	10,30	14,50	16,05	17,45	21,15	***	***	***
Teja y Madera - 0,6	6,75	7,50	9,60	10,25	12,50	14,50	16,50	19,80	21,85	27,75	34,30

BAJO PEDIDO A MEDIDA * Desarrollo: Suma de las cotas en milímetros

CHAPA LISA DE ACERO	€/m ²	€/UD
CHAPA LISA TEJA 8004, ALBERO ENVEJECIDO	3.000 x 1.250 x 0,6	26,20 98,25
CHAPA LISA, PIZARRA	3.000 x 1.250 x 0,6	28,25 105,95
CHAPA LISA IMITACIÓN MADERA	3.000 x 1.070 x 0,6	28,25 105,95

BAJO PEDIDO

CÁLCULO DE CORTES EN PANEL TEJA

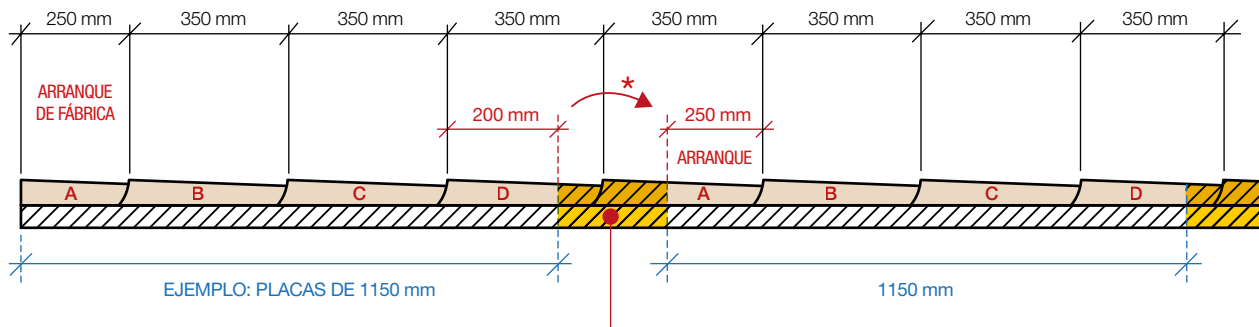

En cada corte hay que avanzar* lo suficiente como para iniciar la siguiente placa en el mismo punto (arranque de 250 mm.), con el fin que encajen lateralmente.



* (Siempre se generará una merma en cada corte, a menos que las piezas sean de una medida múltiplo de 350 mm.)

CUBIERTA LANA ROCA



GMPANEL CUBIERTA LANA DE ROCA (50) - BLANCO PIRINEO / BLANCO P. (SIMILAR, RAL 9003)

CÓDIGO: 0068 **BAJO PEDIDO**

LONGITUDES ▶ A MEDIDA		ANCHO ÚTIL ▶ 1000 mm			
 A2s1d0	REI 30				
 13,50 Kg/m ²				ESPESOR	PRECIO €/M ²
90 kg				50 mm	56,40
3250 mm. máx.					
K(W/m ² K)= 0,77	INTERIOR PERFILADO ESTÁNDAR				





GMPANEL CUBIERTA LANA DE ROCA (50) ABSORCIÓN ACÚSTICA - BP / BP (SIMILAR, RAL 9003)

CÓDIGO: 0008 **BAJO PEDIDO**

LONGITUDES ▶ A MEDIDA		ANCHO ÚTIL ▶ 1000 mm			
 A2s1d0	33 db				
 12,90 Kg/m ²				ESPESOR	PRECIO €/M ²
90 kg				50 mm	63,90
3000 mm. máx.					
K(W/m ² K)= 0,77	INTERIOR PERFORADO				

GMPANEL CUBIERTA LANA DE ROCA (80) - BLANCO PIRINEO / BLANCO P. (SIMILAR, RAL 9003)

CÓDIGO: 0008B **BAJO PEDIDO**

LONGITUDES ▶ A MEDIDA		ANCHO ÚTIL ▶ 1000 mm			
 A2s1d0	REI 60				
 16,50 Kg/m ²				ESPESOR	PRECIO €/M ²
90 kg				80 mm	69,05
4250 mm. máx.					
K(W/m ² K)= 0,49	INTERIOR PERFILADO ESTÁNDAR				

FACHADA ESTÁNDAR, LANA ROCA Y ACCESORIOS



PANEL FACHADA ESTÁNDAR
PANEL FACHADA LANA ROCA
ACCESORIOS FACHADA

SERVICIOS

* PRECIOS NETOS 

DESPIECE Y CORTE
TRANSVERSAL
GRATUITOS

DISPONIBILIDAD
DE MUESTRAS
GRATUITAS

CORTE
LONGITUDINAL
20,00 €/ud.*

CORTE: 3000mm MÁXIMO

CORTE PARA
FACILITAR SOLAPE
10,00 €/ud.*

CORTE Y VACIADO
PARA SOLAPE
20,00 €/ud.*

MÁXIMO: 6000mm

TEJA
Y PIZARRA
30,00 €/ud.*

CONSULTAR DISPONIBILIDAD / PLAZOS



FACHADA ESTÁNDAR

GMPANEL TORNILLO VISTO (30) - BLANCO PIRINEO / BLANCO PIRINEO - (SIMILAR, RAL 9003)

CÓDIGO: 0004

STOCK

LONGITUDES	2000 - 2500 - 3000 - 3500 - 4000 - 5000 - 6000 - 7000 mm	ANCHO ÚTIL	1000 mm		
 Bs2d0			ESPESOR	PRECIO €/M ²	FICHA TÉCNICA 
 7,00 Kg/m ²			30mm	31,55	
90 kg 2000 mm. máx.					
K(W/m ² K)= 0,74					
PERFILADO POR AMBAS CARAS (PUNTA DIAMANTE / PERFILADO ESTÁNDAR)					

GMPANEL TORNILLO VISTO (30) - LISO - LISO / LISO - B.PIRINEO / B.PIRINEO (SIMILAR, RAL 9003)

CÓDIGO: 0006

STOCK

LONGITUDES	2500 - 3000 - 5000 - 6000 mm	ANCHO ÚTIL	1000 mm		
 Bs2d0			ESPESOR	PRECIO €/M ²	FICHA TÉCNICA 
 8,70 Kg/m ²			30mm	41,20	
80 kg 2750 mm. máx.					
K(W/m ² K)= 0,767					
LISO AMBAS CARAS					

GMPANEL TORNILLO OCULTO (40) - IMITACIÓN HORMIGÓN / BLANCO PIRINEO (SIMILAR, RAL 9003)

CÓDIGO: 0148

STOCK

LONGITUDES	2500 - 3000 - 5000 - 6000 mm	ANCHO ÚTIL	1000 mm		
 Cs3d0			ESPESOR	PRECIO €/M ²	FICHA TÉCNICA 
 10,28 Kg/m ²			40mm	52,90	
102 kg 3000 mm. máx.					
K(W/m ² K)= 0,54					
EXTERIOR IMITACIÓN HORMIGÓN / PERFIL ESTÁNDAR					

FACHADA ESTÁNDAR

GMPANEL TORNILLO OCULTO (50) - BLANCO PIRINEO / BLANCO PIRINEO (SIMILAR, RAL 9003)

CÓDIGO: 0148B

STOCK

LONGITUDES

2500 - 3000 - 5000 - 6000 mm

ANCHO ÚTIL

1000 mm



Bs1d0



PIR



ESPESOR

PRECIO €/M²

FICHA TÉCNICA

Kg 9,67 Kg/m²

106 kg

3500 mm. máx.

K(W/m²K)= 0,43



50mm

44,55



PERFILADO POR AMBAS CARAS (PUNTA DIAMANTE / PERFILADO ESTÁNDAR)

GMPANEL TORNILLO VISTO (50) - BLANCO PIRINEO / BLANCO PIRINEO (SIMILAR, RAL 9003)

CÓDIGO: 0178

STOCK

LONGITUDES

2500 - 3000 - 5000 - 6000 mm

ANCHO ÚTIL

1000 mm



Bs2d0



ESPESOR

PRECIO €/M²

FICHA TÉCNICA

Kg 7,80 Kg/m²

95 kg

2750 mm. máx.

K(W/m²K)= 0,41



50mm

37,40



PERFILADO POR AMBAS CARAS (PUNTA DIAMANTE / PERFILADO ESTÁNDAR)

GMPANEL TORNILLO VISTO (60) LISO - LISO / LISO - B.PIRINEO / BLANCO P. (SIMILAR, RAL 9003)

CÓDIGO: 0059

STOCK

LONGITUDES

2500 - 3000 - 5000 - 6000 mm

ANCHO ÚTIL

1000 mm



Bs2d0



ESPESOR

PRECIO €/M²

FICHA TÉCNICA

Kg 9,94 Kg/m²

85 kg

3750 mm. máx.

K(W/m²K)= 0,36



60mm

52,80



LISO POR AMBAS CARAS

FACHADA ESTÁNDAR

GMPANEL TORNILLO VISTO (60) LISO - LISO / LISO - GRIS 7016 / GRIS 7016

CÓDIGO: 0059B

STOCK

LONGITUDES

4500 - 5300 - 6100 mm

ANCHO ÚTIL

1000 mm

 **Bs2d0**

 9,94 Kg/m²

85 kg
3750 mm. máx.

K(W/m²K)= 0,36



CE

ESPESOR

60mm

PRECIO €/M²

60,30

FICHA TÉCNICA



LISO POR AMBAS CARAS

GMPANEL FRIGORÍFICO (80) LISO - LISO / LISO - B.PIRINEO / BLANCO P. (SIMILAR, RAL 9003)

CÓDIGO: 0072B

STOCK

LONGITUDES

2500 - 3000 - 5000 - 6000 mm

ANCHO ÚTIL

1125 mm

 **Bs1d0**

 13,40 Kg/m²

80 kg
4200 mm. máx.

K(W/m²K)= 0,25

 **PIR**



CE

ESPESOR

80mm

PRECIO €/M²

59,50

FICHA TÉCNICA



LISO POR AMBAS CARAS

FACHADA LANA ROCA

GMPANEL LANA DE ROCA (50) - ABSORCIÓN ACÚSTICA - BLANCO P. / BLANCO P. (SIMILAR, RAL 9003) **CÓDIGO: 0071** **STOCK**

LONGITUDES → 2500 - 3000 - 5000 - 6000 mm		ANCHO ÚTIL → 1000 mm	
 A2s1d0	29 db	ESPESOR	PRECIO €/M ²
 12,00 Kg/m ²		50mm	58,20
90 kg			
2250 mm. máx.			
K(W/m ² K)= 0,76	CHAPA PERFORADA UNA CARA		

GMPANEL FACHADA LANA DE ROCA (50) - BLANCO PIRINEO / BLANCO PIRINEO (SIMILAR, RAL 9003) **CÓDIGO: 0174** **STOCK**

LONGITUDES → 2500 - 3000 - 5000 - 6000 mm		ANCHO ÚTIL → 1000 mm	
 A2s1d0	EI 30	ESPESOR	PRECIO €/M ²
 12,60 Kg/m ²		50mm	50,80
95 kg			
2500 mm. máx.			
K(W/m ² K)= 0,76	PERFILADO ESTÁNDAR AMBAS CARAS		

GMPANEL FACHADA LANA DE ROCA (80) - BLANCO PIRINEO / BLANCO P. (SIMILAR, RAL 9003) **CÓDIGO: 0069** **STOCK**

LONGITUDES → 2500 - 3000 - 5000 - 6000 mm		ANCHO ÚTIL → 1000 mm	
 A2s1d0	EI 60	ESPESOR	PRECIO €/M ²
 15,60 Kg/m ²		80mm	63,70
100 kg			
3250 mm. máx.			
K(W/m ² K)= 0,50	PERFILADO ESTÁNDAR AMBAS CARAS		

GMPANEL FACHADA LANA DE ROCA (100) - BLANCO PIRINEO / BLANCO P. (SIMILAR, RAL 9003) **CÓDIGO: 0070** **STOCK**

LONGITUDES → 3000 - 6000 mm		ANCHO ÚTIL → 1000 mm	
 A2s1d0	EI 120	ESPESOR	PRECIO €/M ²
 17,60 Kg/m ²		100mm	68,50
95 kg			
3750 mm. máx.			
K(W/m ² K)= 0,40	PERFILADO ESTÁNDAR AMBAS CARAS		

FACHADA ESTÁNDAR

ACCESORIOS REMATERÍA ESTÁNDAR FACHADA				ESPESOR (mm.)	COLOR	LONGITUD (mm.)	PRECIO €/UD
CERRRES	Remate Cierre 30			0,6	BLANCO PIRINEO	1.500	7,45
						3.000	14,90
	Remate Cierre 40			0,6	BLANCO PIRINEO	1.500	7,45
						3.000	14,90
	Remate Cierre 50			0,6	BLANCO PIRINEO	1.500	7,80
						3.000	15,60
Remate Cierre 60			0,6	BLANCO PIRINEO	1.500	10,15	
					3.000	20,30	
Remate Cierre 80			0,6	BLANCO PIRINEO	1.500	10,15	
					3.000	20,30	
Remate Cierre 100			0,6	BLANCO PIRINEO	1.500	10,15	
					3.000	20,30	
ÁNGULOS	Remate Esquinero Exterior 60x60			0,6	BLANCO PIRINEO	1.500	7,45
						3.000	14,90
	Remate Esquinero Exterior 120x120			0,6	BLANCO PIRINEO	1.500	11,95
						3.000	23,90

FACHADA ESTÁNDAR

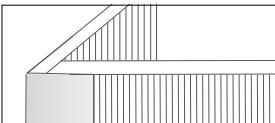
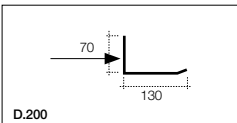
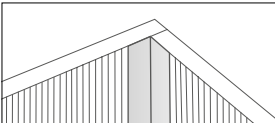
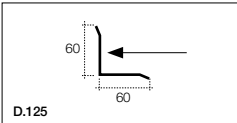
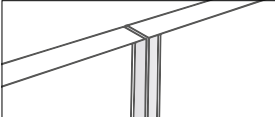
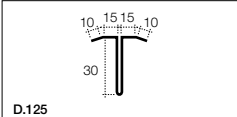
ACCESORIOS REMATERÍA ESTÁNDAR FACHADA				ESPESOR (mm.)	COLOR	LONGITUD (mm.)	PRECIO €/UD
ÁNGULOS	Remate Esquinero Exterior 70x130			0,6	BLANCO PIRINEO	1.500	10,15
						3.000	20,30
ÁNGULOS	Remate Esquinero Interior 60x60			0,6	BLANCO PIRINEO	1.500	7,45
						3.000	14,90
OTROS	Remate Unión Fachada "T"			0,6	BLANCO PIRINEO	1.500	7,45
						3.000	14,90

REMATERÍA A MEDIDA

CÓDIGO: 0039

€/ml	REMATES DE ACERO GALVANIZADO											
	Esp./Desarrollo (mm.)*	125	156	200	250	333	400	500	625	750	1.000	1.250
0,60	4,20	4,70	5,90	7,10	7,80	10,10	11,80	14,10	14,10	16,40	20,60	25,10
0,80	5,20	5,60	7,30	8,60	9,60	12,40	14,60	17,40	17,40	20,50	26,10	31,90
1,00	6,00	6,50	8,70	9,80	12,10	14,60	17,30	21,00	24,20	31,60	38,60	
1,20	6,90	7,70	9,80	11,90	14,50	17,80	20,50	25,30	30,10	39,10	47,90	
1,50	8,20	10,10	12,60	14,60	17,10	21,30	27,80	34,70	41,70	55,20	68,70	
€/ml	REMATES DE ACERO PRELACADO											
0,60	4,80	5,20	6,80	8,00	8,80	11,50	13,50	17,90	19,70	25,00	30,90	
0,80	7,10	7,60	11,60	12,40	15,00	17,40	19,80	23,80	26,30	33,30	41,30	
Troquelados Std	***	***	***	10,30	14,50	16,05	17,45	21,15	***	***	***	***

BAJO PEDIDO

A MEDIDA

* Desarrollo: Suma de las cotas en milímetros

CHAPA LISA DE ACERO		€/m ²	€/UD
CHAPA LISA BLANCO PIRINEO	3.000 x 1.250 x 0,6	20,80	78,00
STOCK			

La clasificación que emplea el Código Técnico viene definida por los siguientes parámetros, anulando las antiguas clases M0, M1, M2 y M3.

EQUIVALENCIA APROXIMADA DE NOMENCLATURAS

Revestimiento de paredes y techos	M0	A2s1D0	M2	C-s3, d0 (*)
	M1	Bs1d0	M3	D-s3, d0

(*) Cuando esta clase pertenezca a un material cuyo grosor sea menor de 1mm. y cuya masa sea menor de 1 Kg/m², también será válida para aquellas aplicaciones para las que se exija clase M1.

Contribución a la propagación del fuego

- A1:** No combustible; sin contribuir al fuego en grado máximo.
- A2:** No combustible; sin contribuir al fuego en grado menor.
- B:** Combustible con contribución muy limitada al fuego.
- C:** Combustible con contribución limitada al fuego.
- D:** Combustible con contribución media al fuego.
- E:** Combustible con contribución alta al fuego.
- F:** Sin clasificar.

Opacidad de los humos producidos

- s1:** Baja opacidad.
- s2:** Opacidad media.
- s3:** Alta opacidad.

Caída de gotas o partículas inflamadas

- d0:** No las produce.
- d1:** Las produce en grado medio.
- d2:** Las produce en grado alto.

OTROS CERRAMIENTOS

(BAJO CONSULTA)

OTROS PANELES DEL GRUPO

PANEL "A MEDIDA"

PANEL CUBIERTA DE ALUMINIO

PANEL CUBIERTA LANA DE ROCA

PANEL FRIGORÍFICO (Y ACCESORIOS)

SERVICIOS

* PRECIOS NETOS 

DESPIECE Y CORTE
TRANSVERSAL
GRATUITOS

DISPONIBILIDAD
DE MUESTRAS
GRATUITAS

CORTE
LONGITUDINAL
20,00 €/ud.*

CORTE: 3000mm MÁXIMO

CORTE PARA
FACILITAR SOLAPE
10,00 €/ud.*

CORTE Y VACIADO
PARA SOLAPE
20,00 €/ud.*

MÁXIMO: 6000mm

TEJA
Y PIZARRA
30,00 €/ud.*



CONSULTAR DISPONIBILIDAD / PLAZOS



OTROS PANELES (DISPONIBLES EN OTRAS DELEGACIONES DEL GRUPO)

GMPANEL CUBIERTA 3G (30) - BLANCO PIRINEO / BLANCO PIRINEO (SIMILAR, RAL 9003)

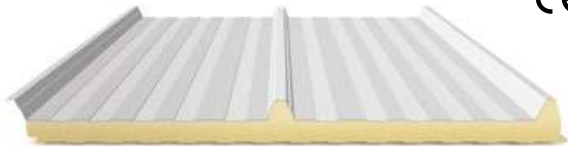
CÓDIGO: 0160 **BAJO PEDIDO***

LONGITUDES	2000 - 2500 - 3000 - 4000 - 5000 - 6000 - 7000 mm	ANCHO ÚTIL	1000 mm				
 6,30 Kg/m ²		CE	ESPESOR	PRECIO €/M ²	FICHA TÉCNICA 		
 84 kg						30mm	28,90
1750 mm. máx.							
K(W/m ² K)= 0,73	INTERIOR PERFILADO ESTÁNDAR						

GMPANEL TORNILLO VISTO (35) LISO - LISO / LISO - BLANCO P. / BLANCO P. (SIMILAR, RAL 9003)

CÓDIGO: 0006B **BAJO PEDIDO***

LONGITUDES	2500 - 3000 - 3500 - 4000 - 5000 - 6000 - 7000 mm	ANCHO ÚTIL	1000 mm				
 Cs3d0		CE	ESPESOR	PRECIO €/M ²	FICHA TÉCNICA 		
 8,96 Kg/m ²						35mm	39,55
 84 kg							
3750 mm. máx.	LISO AMBAS CARAS						
K(W/m ² K)= 0,66							

GMPANEL TORNILLO OCULTO (35) - CORTEN - IMITACIÓN CORTEN / BLANCO PIRINEO

CÓDIGO: 0159 **BAJO PEDIDO***

LONGITUDES	2500 - 3000 - 5000 - 6000 mm	ANCHO ÚTIL	1000 mm				
 Cs3d0		CE	ESPESOR	PRECIO €/M ²	FICHA TÉCNICA 		
 10,28 Kg/m ²						35mm	52,80
 85 kg							
3000 mm. máx.	LISO EXTERIOR / PERFILADO INTERIOR						
K(W/m ² K)= 0,62							

OTROS PANELES (DISPONIBLES EN OTRAS DELEGACIONES DEL GRUPO)

GMPANEL TORNILLO VISTO (50) LISO - LISO / LISO - BLANCO P. / BLANCO P. (SIMILAR, RAL 9003)

CÓDIGO: 0019

BAJO PEDIDO*

LONGITUDES

2500 - 3000 - 3500 - 4000 - 5000 - 6000 - 7000 mm

ANCHO ÚTIL

1000 mm

Cs3d0

Kg 9,55 Kg/m²

86 kg
3000 mm. máx.

K(W/m²K)= 0,45



CE

ESPESOR

50mm

PRECIO €/M²

45,40

FICHA TÉCNICA



LISO AMBAS CARAS

GMPANEL TORNILLO VISTO (40) MADERA - 2 CARAS - IM. MADERA OSCURA / IM. MADERA OSCURA

CÓDIGO: 0057C

BAJO PEDIDO*

LONGITUDES

2500 - 3000 - 5000 - 6000 mm

ANCHO ÚTIL

1000 mm

Bs2d0

Kg 9,10 Kg/m²

90 kg
2500 mm. máx.

K(W/m²K)= 0,57



CE

ESPESOR

40mm

PRECIO €/M²

54,25

FICHA TÉCNICA



MADERA AMBAS CARAS

CONSULTAR DISPONIBILIDAD Y PLAZOS

SUMAR COSTE DE TRANSPORTE ENTRE ALMACENES: 90,00 €

PANEL A MEDIDA

GMPANEL CUBIERTA - TORNILLERÍA OCULTA - INTERIOR BLANCO PIRINEO

CÓDIGO: 0009 **BAJO PEDIDO**

LONGITUDES **A MEDIDA**

Bs1d0

PIR

DISPONIBILIDAD DE COLORES. VER PÁGINA 41



CE

ANCHO ÚTIL **1150 mm**

ESPESOR	PRECIO €/M ²
30mm	42,30
40mm	45,20
50mm	48,40
60mm	51,90
80mm	59,90
100mm	68,00
120mm	76,50

SECCIÓN TÉCNICA PANEL

*Cotas interiores

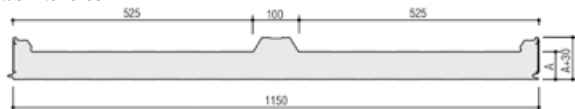

MONTAJE

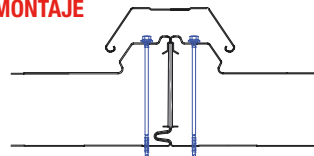

GMPANEL FACHADA - TORNILLERÍA OCULTA - INTERIOR BLANCO PIRINEO

CÓDIGO: 0010 **BAJO PEDIDO**

LONGITUDES **A MEDIDA**

Bs1d0

PIR

DISPONIBILIDAD DE COLORES. VER PÁGINA 41



CE

ANCHO ÚTIL **1150 mm**

ESPESOR	PRECIO €/M ²
35mm	47,40
40mm	48,80
50mm	51,90
60mm	55,30
80mm	63,30
100mm	71,10

PERFILADO AMBAS CARAS.
(Posibilidad de otros perfilados)

SECCIÓN TÉCNICA PANEL

*Cotas interiores

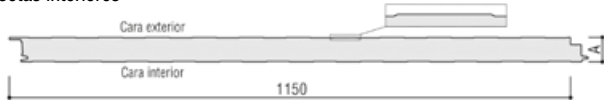

MONTAJE

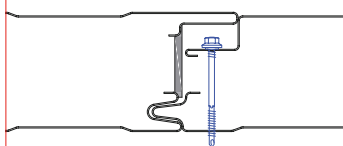

PANEL A MEDIDA



COLORES

								
BLANCO PURO RAL 9010	BLANCO PIRINEO COLOR 1006	BLANCO GRISÁCEO RAL 9002	MARFIL CLARO RAL 1015	ARENA COLOR 2000	CALABAZA COLOR 6002	COBRE CLARO COLOR 7071 (Metalizado)	PALISANDER TERRACOTA COLOR WOODPATE	PALISANDER ANTICATO COLOR WOODPAAN
								
ROJO TRÁFICO RAL 3020	ROJO TEJA COLOR 7001	IMITACIÓN CORTEN COLOR PC231	ROJO PARDO RAL 8012	TABACO COLOR 2005	VERDE RESEDA RAL 6011	VERDE NAVARRA COLOR 3000	AZUL LAGO COLOR 4000	AZUL ULTRAMAR RAL 5002
								
AZUL GRISÁCEO RAL 5008	GRIS PERLA COLOR 5001	GRIS TRÁFICO RAL 7042	ALUMINIO BLANCO RAL 9006 (Metalizado)	GRIS ALUMINIO RAL 9007 (Metalizado)	GRIS PIZARRA RAL 7015	GRIS ANTRACITA RAL 7016	GRIS SOMBRA RAL 7022	NEGRO INTENSO RAL 9005

COLORES ESTÁNDAR PANEL CUBIERTA

	
BLANCO PIRINEO COLOR 1006	ROJO TEJA COLOR 7001

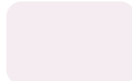
COLORES ESTÁNDAR PANEL FACHADA

	
BLANCO PIRINEO COLOR 1006	ALUMINIO BLANCO RAL 9006 (Metalizado)





ESPECIALES. El resto.
(- de 100m², recargo de 300 €).
Opciones de tono madera, consultar.

*Los colores representados son aproximados

PANEL FRIGORÍFICO

GMPANEL FRIGORÍFICO LISO (60) - BLANCO PIRINEO / BLANCO PIRINEO (SIMILAR, RAL 9003)

CÓDIGO: 0054B **BAJO PEDIDO**

LONGITUDES ▶ A MEDIDA		ANCHO ÚTIL ▶ 1185 mm		
 Bs1d0  11,00 Kg/m ² 80 kg 3820 mm. máx. K(W/m ² K)= 0,35				
			ESPESOR	PRECIO €/M ²
			60mm	58,20
			LISO AMBAS CARAS	

GMPANEL FRIGORÍFICO LISO (80) - BLANCO PIRINEO / BLANCO PIRINEO (SIMILAR, RAL 9003)

CÓDIGO: 0072 **BAJO PEDIDO**

LONGITUDES ▶ A MEDIDA		ANCHO ÚTIL ▶ 1185 mm		
 Bs1d0  11,90 Kg/m ² 80 kg 4200 mm. máx. K(W/m ² K)= 0,27				
			ESPESOR	PRECIO €/M ²
			80mm	65,20
			LISO AMBAS CARAS	

GMPANEL FRIGORÍFICO LISO (100) - BLANCO PIRINEO / BLANCO PIRINEO (SIMILAR, RAL 9003)

CÓDIGO: 0073 **BAJO PEDIDO**





LONGITUDES ▶ A MEDIDA		ANCHO ÚTIL ▶ 1185 mm		
 Bs1d0  12,80 Kg/m ² 80 kg 4600 mm. máx. K(W/m ² K)= 0,21				
			ESPESOR	PRECIO €/M ²
			100mm	72,60
			LISO AMBAS CARAS	

GMPANEL FRIGORÍFICO LISO (120) - BLANCO PIRINEO / BLANCO PIRINEO (SIMILAR, RAL 9003)

CÓDIGO: 0054 **BAJO PEDIDO**

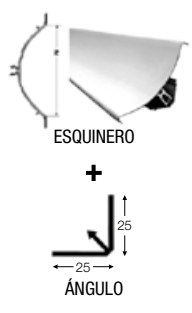
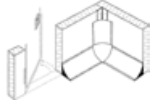
LONGITUDES ▶ A MEDIDA		ANCHO ÚTIL ▶ 1185 mm		
 Bs1d0  13,40 Kg/m ² 80 kg 5000 mm. máx. K(W/m ² K)= 0,18				
			ESPESOR	PRECIO €/M ²
			120mm	80,00
			LISO AMBAS CARAS	

ACCESORIOS FRIGORÍFICO

<p>Conjunto Perfil Sanitario P.S. esquinero interior 90 mm.</p> <p>290P PVC</p> <p>+</p> <p>P. S. ángulo de fijación Aluminio 25x25 mm.</p> <p>315P ALUMINIO</p>	 <p>ESQUINERO</p> <p>ÁNGULO</p>	<p>COLOR</p> <p>BLANCO</p>	<p>€/ML</p> <p>5,45</p>	<p>Perfil Sanitario tapa esquinero interior</p>		<p>COLOR</p> <p>BLANCO</p>	<p>€/UD</p> <p>0,70</p>
<p>MEDIDAS 4.000 MM.</p>				<p>TIPO 288 PVC MEDIDAS -</p>			
<p>Angular Exterior (para conjunto sanitario)</p>		<p>COLOR</p> <p>BLANCO</p>	<p>€/UD</p> <p>1,75</p>	<p>Bulón Chino M-10</p>		<p>COLOR</p> <p>BLANCO</p>	<p>€/UD</p> <p>1,80</p>
<p>Perfil Sanitario Ángulo Triple</p>		<p>COLOR</p> <p>BLANCO</p>	<p>€/UD</p> <p>1,75</p>	<p>Bulón Japonés M-10 Instalación desde interior y exterior</p>		<p>COLOR</p> <p>BLANCO</p>	<p>€/UD</p> <p>1,80</p>
<p>TIPO 295 PVC MEDIDAS -</p>				<p>Zócalo de polietileno (Incluye tapones)</p> <p>TAMAÑO €/UD</p> <p>200 MM 56,70</p> <p>300 MM 73,35</p> <p>500 MM 110,00</p> <p>TIPO - MEDIDAS 2.000 MM.</p>			

CHAPA METÁLICA Y ACCESORIOS



CHAPA METÁLICA GRECADA CUBIERTA
FORJADO COLABORANTE
CHAPA METÁLICA ONDULADA MINIONDA
CHAPA TABIQUE PLUVIAL
CHAPA METÁLICA DECORATIVA
ACCESORIOS

CHAPA METÁLICA

CHAPA METÁLICA GRECADA - GALVANIZADA

CÓDIGO: 0012

STOCK

LONGITUDES

3000 - 6000 mm

ANCHO ÚTIL

1030 mm

 5,61 Kg/m²

111 kg
1800 mm. máx.

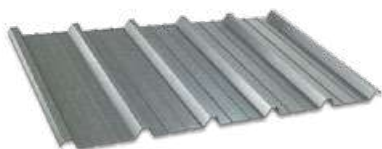

CE

ESPESOR

0,6mm

COLOR

GALVANIZADO

PRECIO €/M²

15,90

FICHA TÉCNICA



PERFIL 30 / 206

CHAPA METÁLICA GRECADA CUBIERTA - PRELACADA

CÓDIGO: 0012B

STOCK

LONGITUDES

3000 - 6000 mm

ANCHO ÚTIL

1030 mm

 5,72 Kg/m²

131 kg
1750 mm. máx.



CE

ESPESOR

0,6mm

COLOR

BLANCO PIRINEO
ROJO TEJA
VERDE NAVARA

OTROS
COLORES

PRECIO €/M²

16,20

17,95

FICHA TÉCNICA



PERFIL 30 / 206

FORJADO COLABORANTE

CÓDIGO: 0014

STOCK

LONGITUDES

6000 mm

ANCHO ÚTIL

880 mm





CE

ESPESOR

0,8mm

COLOR

GALVANIZADO

PRECIO €/M²

25,75

FICHA TÉCNICA



PERFIL 60 / 220 / 880

CONSULTAR OPCIONES DE ESPESOR, ACABADOS Y COLORES

CHAPA METÁLICA - TABIQUES PLUVIALES

CHAPA METÁLICA ONDULADA MINIONDA

CÓDIGO: 0011

STOCK

LONGITUDES

3000 - 6000 mm

ANCHO ÚTIL

1064 mm

 <p>5,89 Kg/m²</p> <p>76 kg 2000 mm. máx.</p>	<p>CE</p> <p>ESPESOR</p> <p>0,6mm</p>	<p>COLOR</p> <p>GALVANIZADA</p> <p>PRELACADO</p>	<p>PRECIO €/M²</p> <p>16,85 17,95</p>	<p>FICHA TÉCNICA</p> 

CHAPA TABIQUE PLUVIAL - 14/195/590

CÓDIGO: 0013

BAJO PEDIDO

LONGITUDES

2500 mm

ANCHO

590 mm

 <p>5,89 Kg/m²</p> <p>76 kg 2000 mm. máx.</p> <p>ANCHO ÚTIL: 560 MM</p>	<p>ESPESOR</p> <p>0,6mm</p>	<p>COLOR</p> <p>GRIS PERLA</p> <p>SALMÓN</p> <p>BLANCO P.</p> <p>ARENA</p>	<p>PRECIO €/M²</p> <p>22,25</p>	<p>FICHA TÉCNICA</p> 

ACCESORIOS (REMATERÍA TABIQUE PLUVIAL)

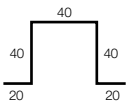
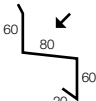
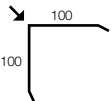
<p>OMEGA GALVA</p>  <p>6.000 mm</p> <p>2,55 €/ML</p>	<p>ARRANQUE INFERIOR</p>  <p>2.500 mm</p> <p>19,90 €/UD</p>	<p>ESQUINERO LATERAL</p>  <p>2.500 mm</p> <p>16,90 €/UD</p>
--	---	---

CHAPA TRAPEZOIDAL ESPECIAL (PERFIL A MEDIDA)

CÓDIGO: 0012C

BAJO PEDIDO

LONGITUDES

A MEDIDA

REPLICAMOS CUALQUIER PERFIL PARA REHABILITACIONES Y REPARACIONES



CE

<p>ESPESOR</p> <p>0,6mm</p>	<p>COLOR</p> <p>GALVANIZADA</p> <p>PRELACADO</p>	<p>PRECIO €/M²</p> <p>28,60 31,40</p>	<p>Imprescindible dibujo del perfil con cotas y ángulos o muestra física.</p>

CHAPA METÁLICA DECORATIVA

Amplia gama de perfiles de chapa en acero, especialmente indicada para revestimiento de fachadas arquitectónicas e interiores singulares. Posibilidad real de fabricación de pequeñas cantidades y completa disponibilidad de colores y acabados (perforado)

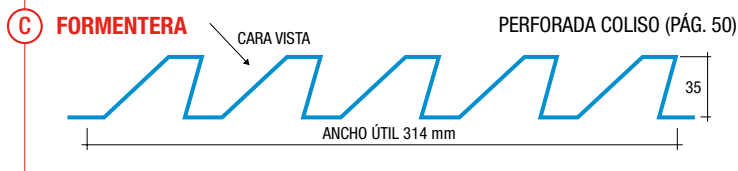
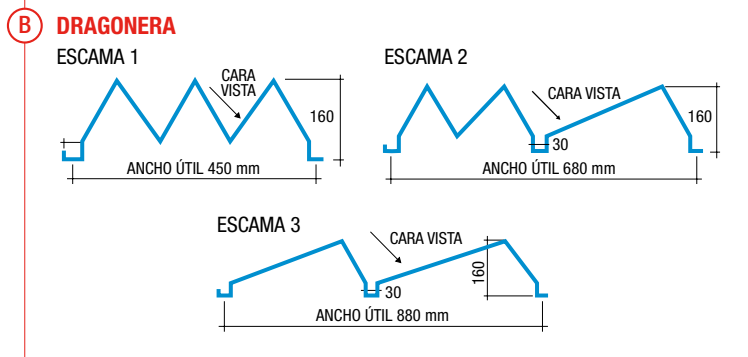
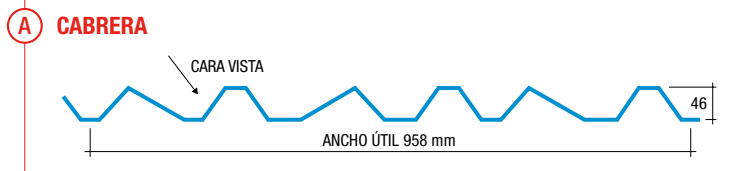

PRELAC. 0,6 MM

PRECIO €/M²

32,70

PRECIO €/M²

ESCAMA 1

54,10

ESCAMA 2

45,10

ESCAMA 3

35,40

PRECIO €/M²

64,20



CHAPA METÁLICA DECORATIVA

A MENORCA



PRELAC. 0,6 MM

PRECIO €/M²

51,60



A MENORCA M*



PRECIO €/M²

51,60



B MALLORCA 6

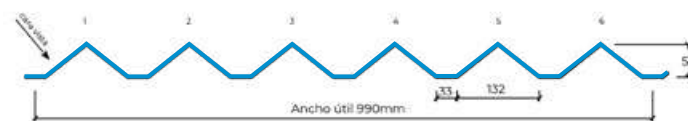

PRECIO €/M²

31,70



C MALLORCA 7



PRECIO €/M²

35,80

CHAPA METÁLICA DECORATIVA

A MALLORCA 8

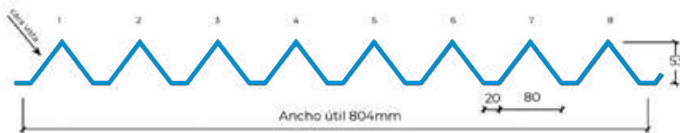

PRECIO €/M²

38,50



B BANDEJAS ARQUITECTÓNICAS

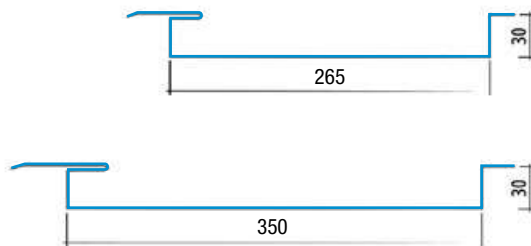

PRECIO €/ML

265

14,60



C IBIZA

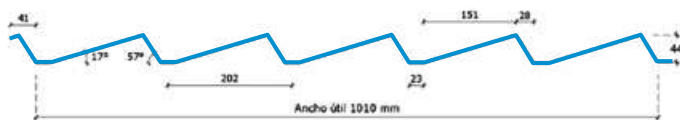

PRECIO €/M²

31,10



CHAPA METÁLICA DECORATIVA

COLORES DISPONIBLES



BLANCO PIRINEO
COLOR 1006



BLANCO puro
RAL 9010



CREMA BIDASOA
COLOR 2002



ARENA
COLOR 2000



TABACO
COLOR 2005



VERDE NAVARRA
COLOR 3000



VERDE PRIMAVERA
COLOR 3001



GRIS ALUMINIO
RAL 9007



AZUL LAGO
COLOR 1006



AZUL ULTRAMAR
RAL 5002



AZUL ARDOISE
COLOR 5008



ROJO TEJA
COLOR 7001



ROJO BAZTÁN
COLOR 7002



ROJO CORAL
COLOR 7004



TEJA
RAL 8004



GRIS PERLA
COLOR 5001



SILMETALIC
RAL 9006



GRIS ALUMINIO
RAL 9007



GRIS PIZARRA
RAL 7015



GRIS ANTRACITA
RAL 7016



GRIS SOMBRA
RAL 7022



NEGRO
COLOR 9005

IMITACIÓN MADERA



MADERA NORUEGA



MADERA SUECIA



MADERA FINLANDIA

POSIBILIDAD DE PERFORADOS COMPLETOS O PARCIALES. CONSULTAR.

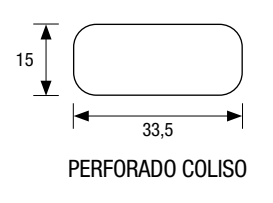
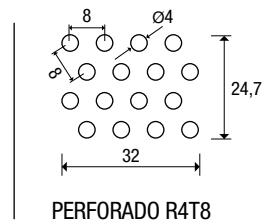

CHAPA METÁLICA DECORATIVA





Aireador estático diseñado para la renovación del aire interior de edificios industriales, fabricados en chapa de acero de alta calidad.

Posibilidad de fabricación con diversos recubrimientos y colores, obteniendo una total integración con el cerramiento.

Es el sistema más utilizado cuando hablamos de ejecución de obra nueva por su fácil colocación y su adaptación a cualquier tipo de cubierta. Existe la posibilidad de suministrarlo en piezas (soporte + remates) para su montaje en obra, o totalmente armado sin soportes.

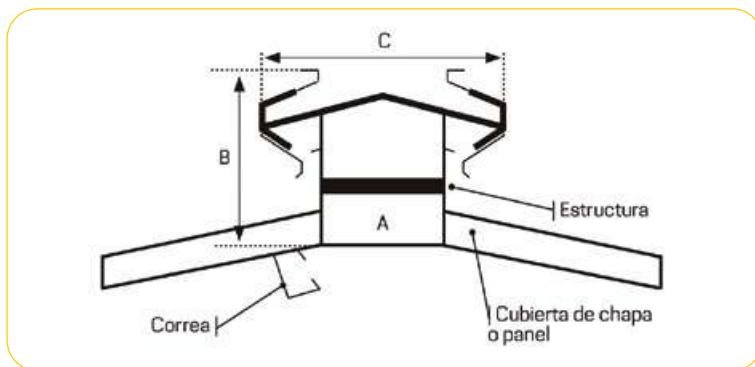

	IR 250 M*	IR 500 M*
PRELACADO (No incluye soporte)	182,40 €/ml.	202,80 €/ml.
GALVANIZADO (No incluye soporte)	165,50 €/ml.	183,70 €/ml.

PRELACADOS (consultar opciones de color) M*: Se entrega montado

! NO SE RECOMIENDAN TRAMOS SUPERIORES A 4 METROS LINEALES

DIMENSIONES (mm.)				
TIPO	A	B	C	PESO Kg/ml.
IR 250 M*	226	466	564	14
IR 500 M*	455	466	800	16,5

Otras medidas, consultar



VARIOS

CÓDIGO: 0045

Bocas Bajante galvanizadas		TUBO	€/UD
		80	10,70
		90	10,70
		110	16,40
		125	17,00

MEDIDAS	70-84-104-114
---------	---------------

Trampilla acceso cubierta		COLOR	€/UD
		GALVANIZADO	410,00

MEDIDAS	600 X 600 MM.
---------	---------------

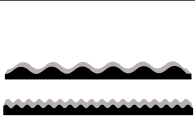
Junta estanca		COLOR	€/UD
		-	1,50

TIPO	MINIONDA - GRAN ONDA - 30/210 CM. - CONSULTAR
------	---

MEDIDAS	1.000 M
---------	---------

Gárgolas		COLOR	€/UD
		GALVANIZADO	245,00
BOCA DE 75, 90, 100, 110 o 125		PRELACADO	245,00

SISTEMAS DE VENTILACIÓN

CÓDIGO: 0119

AIREADOR RESIDENCIAL (ACERO)										
	150 mm		200 mm		250 mm		300 mm		350 mm	
	LACADO	160,00 €/ud.	LACADO	180,00 €/ud.	LACADO	195,00 €/ud.	LACADO	200,00 €/ud.	LACADO	265,00 €/ud.
	GALVANIZ.	125,00 €/ud.	GALVANIZ.	145,00 €/ud.	GALVANIZ.	160,00 €/ud.	GALVANIZ.	170,00 €/ud.	GALVANIZ.	230,00 €/ud.

AIREADOR INDUSTRIAL (ALUMINIO)		
	16" - (400mm)	20" - (500mm)
	985,00 €/ud.	1095,00 €/ud.
	3100 m³/h	4700 m³/h

←
 NOTA: Incluye base y tensores para sujeción en cubierta

↑
 NOTA: Incluye base lacada
 Recargo para base uralita (galva): **115,00€**

€/ml	REMATES DE ACERO GALVANIZADO										
Esp./Desarrollo (mm.)*	125	156	200	250	333	400	500	625	750	1.000	1.250
0,60	4,20	4,70	5,90	7,10	7,80	10,10	11,80	14,10	16,40	20,60	25,10
0,80	5,20	5,60	7,30	8,60	9,60	12,40	14,60	17,40	20,50	26,10	31,90
1,00	6,00	6,50	8,70	9,80	12,10	14,60	17,30	21,00	24,20	31,60	38,60
1,20	6,90	7,70	9,80	11,90	14,50	17,80	20,50	25,30	30,10	39,10	47,90
1,50	8,20	10,10	12,60	14,60	17,10	21,30	27,80	34,70	41,70	55,20	68,70
2,00	10,80	12,10	15,20	19,10	22,90	27,80	37,00	46,30	55,20	73,30	91,10
€/ml	REMATES DE ACERO PRELACADO										
0,60	4,80	5,20	6,80	8,00	8,80	11,50	13,50	17,90	19,70	25,00	30,90
0,80	7,10	7,60	11,60	12,40	15,00	17,40	19,80	23,80	26,30	33,30	41,30
1,00	9,40	11,50	14,40	15,40	18,80	21,70	24,80	29,70	32,80	41,60	51,60
Troquelados Std	***	***	***	10,30	14,50	16,05	17,45	21,15	***	***	***
Troquelados -Teja	***	***	***	17,05	21,40	23,20	24,85	29,20	***	39,35	***
Teja y Madera.-0,6	6,75	7,50	9,60	10,25	12,50	14,50	16,50	19,80	21,85	27,75	34,30

* Desarrollo: Suma de las cotas en milímetros

CHAPA LISA DE ACERO			€/m ²	€/UD
CHAPA LISA BLANCO PIRINEO	STOCK	3.000 x 1.250 x 0,6	20,80	78,00
CHAPA LISA ROJO TEJA		3.000 x 1.250 x 0,6	20,80	78,00
CHAPA LISA TEJA 8004, ALBERO ENVEJECIDO		3.000 x 1.250 x 0,6	26,20	98,25
CHAPA LISA ACERO CORTEN		3.000 x 1.113 x 0,6	26,20	98,25
CHAPA LISA, PIZARRA		3.000 x 1.250 x 0,6	28,25	105,95
CHAPA LISA IMITACIÓN MADERA (CLARA Y OSCURA)		3.000 x 1.070 x 0,6	28,25	105,95

CÓMO CALCULAR EL DESARROLLO DE UN REMATE PARA SU VALORACIÓN

1

Sumar las cotas de cada lado (pliegue) en milímetros.

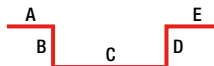

$$\text{DESARROLLO} = A + B + C + D + E$$

2

Una vez tengamos la suma, buscar el desarrollo para su valoración.

En caso de no coincidir la cifra, buscar la inmediatamente superior.



(Ejemplo: Si la suma da como resultado, 140 mm., seleccionaremos el desarrollo 156.)

Al pasar los pedidos es imprescindible detallar, además de las cotas, todos los ÁNGULOS y posición del color.



REMATERÍA A MEDIDA			
€/ml			
Esp./Desarrollo (mm.)*	125	156	
0,60	2,60	2,80	

GMSISTEMA EVACUACIÓN AGUAS - PVC





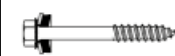





CÓDIGO: 0042

GMCanal Redondeado		COLOR	€/UD
		BLANCO	20,40
		BRONCE	26,30
MEDIDAS		3.000 mm.	
GMCanal Unión con descarga BAJADA EN RECTO, IMPRESCINDIBLE MANGUITO DE UNIÓN		COLOR	€/UD
		BLANCO	12,85
		BRONCE	15,35
UNIDAD		-	
GMJunta Interna		COLOR	€/UD
		BLANCO	8,65
		BRONCE	10,35
UNIDAD		-	
GMTapa Canal redondeado		COLOR	€/UD
		BLANCO	5,25
		BRONCE	6,20
UNIDAD		-	
GMManguito de Unión		COLOR	€/UD
		BLANCO	5,25
		BRONCE	6,45
UNIDAD		-	
GMAngular Canal redondeado		COLOR	€/UD
		BLANCO	12,85
		BRONCE	15,35
UNIDAD		-	

GMCodo 87° 30' Tubo 80		COLOR	€/UD
		BLANCO	5,50
		BRONCE	6,55
UNIDAD		-	
GMTubo redondo ø 80		COLOR	€/UD
		BLANCO	28,55
		BRONCE	37,70
MEDIDAS		3.000 mm.	
GMCollar para tubo 80		COLOR	€/UD
		BLANCO	3,80
		BRONCE	4,35
UNIDAD		-	
GMSoporte para falda REQUIERE GMSOPORTE PARED PARA FIJARSE A LA CANAL		COLOR	€/UD
		BLANCO	1,25
		BRONCE	
UNIDAD		-	
GMSoporte para pared		COLOR	€/UD
		BLANCO	2,65
		BRONCE	3,15
UNIDAD		-	
 			
BLANCO		BRONCE	













TORNILLOS	Tornillo Zincado Autorroscante		ACABADO	MEDIDAS	€/UD
		ZINCADO	6,3X25+P18	0,10	
		6,3X40+P18	0,16		
		6,3X60+P18	0,20		
		6,3X90+P18	0,30		
		6,3X110+P18	0,32		
		6,3X130+P18	0,38		
LLAVE DE VASO	10	BROCA	4mm (DE 1A 2mm) / 5,05mm (DE 2 A 2,9mm)		
TORNILLOS	Tornillo Zincado Autotaladrante (VIGA)		ACABADO	MEDIDAS	€/UD
		ZINCADO	5,5X75XP16	0,40	
		5,5X105+P16	0,55		
		5,5X115+P16	0,65		
LLAVE DE VASO	8	CAPACIDAD DE TALADRO	ENTRE 4 Y 12mm		
TORNILLOS	Tornillo Teja		ACABADO	MEDIDAS	€/UD
		8004	6,3X120+P25 EPDM-AR	0,80	
		6,3X120+P25 EPDM-AT	0,80		
		PIZARRA	6,3X120+P25 EPDM-AR	0,80	
			6,3X120+P25 EPDM-AT	0,80	
AR.: AUTORROSCANTE / AT.: AUTOTALADRANTE					
LLAVE DE VASO	10	BROCA	4mm (DE 1A 2mm) / 5,05mm (DE 2 A 2,9mm)		

ARANDELAS Y TAPONES	Arandelas		ACABADO	DESCRIPCIÓN	€/UD
		GALVA	P18	0,10	
		P25 Doble Estantq.	0,20		
		Gran Onda	0,20		
		Mini Onda	0,20		
Taponos		COLORES	CABEZA HEXAGONAL	0,12	

TORNILLOS	Tornillo Zincado Autotaladrante		ACABADO	MEDIDAS	€/UD
		ZINCADO	6,3X25+P18	0,10	
		6,3X40+P18	0,18		
		6,3X60+P18	0,22		
		6,3X90+P18	0,32		
		6,3X110+P18	0,34		
		6,3X130+P18	0,40		
		6,3X150+P18	0,55		
LLAVE DE VASO	10	CAPACIDAD DE TALADRO	ENTRE 2 Y 6mm		
TORNILLOS	Tornillo Hormigón		ACABADO	MEDIDAS	€/UD
		AZUL	6,5X32+P16	0,18	
		6,5X57+P16	0,20		
		6,5X100+P16	0,35		
		6,5X125+P16	0,45		
LLAVE DE VASO	8	FIJACIÓN MÍNIMA EN EL HORMIGÓN (MACIZO)	25mm		
OTROS	Fijaciones Cosido Chapa		ACABADO	MEDIDAS	€/UD
		BLANCO 8004	4,2X14 AT PLANA	0,12	
		8004 ROJO TEJA PLATA ARENA	TORNILLO "TOR"	0,22	
		8004 PIZARRA BLANCO	REMACHES	0,10	
AR.: AUTORROSCANTE / AT.: AUTOTALADRANTE					
OTROS	DESCRIPCIÓN		€/UD		
		GANCHO DE FIJACIÓN 52X150MM	0,50		
		SOPORTE DE ONDA POLIPROPILENO ONDA GRANDE	0,35		
		SOPORTE DE ONDA POLIPROPILENO MINI ONDA	0,25		
		SOPORTE DE ONDA POLIPROPILENO ONDA GRECA	0,35		
		SOPORTE CANALÓN CUBIERTA 30MM	1,20		
	SOPORTE CANALÓN CUBIERTA 50MM	1,40			
	GRAPA TORNERÍA OCULTA	0,60			

ESTRUCTURA LIGERA (SIN SOLDADURA)

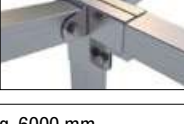
CÓDIGO: 0121

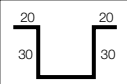
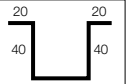
PIEZAS ÚNICAMENTE COMPATIBLES CON TUBO DE 50X50MM.		ACABADO	€/UD	PIEZAS ÚNICAMENTE COMPATIBLES CON TUBO DE 50X50MM.		ACABADO	€/UD		
Pza. Unión pared pendiente 14		GALVA	7,15	Pza. Unión "T" 4 partes con pendiente 07		GALVA	20,85		
Pza. Arranque recto 13		GALVA	12,25	Pza. Unión "L" delantera derecha con pendiente 03D		GALVA	22,75		
Pza. Unión "T" 4 partes recto 11		GALVA	27,30	Pza. Unión "L" delantera izquierda con pendiente 03I		GALVA	22,75		
Pza. Unión "T" 3 partes recto 05		GALVA	18,00	Pieza Lateral con pendiente 17		GALVA	5,15		
Pieza Fijación a pared 15		GALVA	4,85	Pieza Unión cruzada 16		GALVA	5,15		
Pza. Unión 4 P. 2 aguas 04		GALVA	24,30	Pza. Unión "L" Recta 02		GALVA	21,25		
Tubo (1,5 mm.) 50 x 50 mm. Long. 6000 mm.		GALVA	39,00	Tapón para tubo 50 x 50 mm.		GRIS	0,80		
Omega 30 Galva		ESPESOR (mm.) 0,6	LONGITUD (mm.) 6000	€/ML 2,40	Omega 40 Galva		ESPESOR (mm.) 0,7	LONGITUD (mm.) 6000	€/ML 2,55



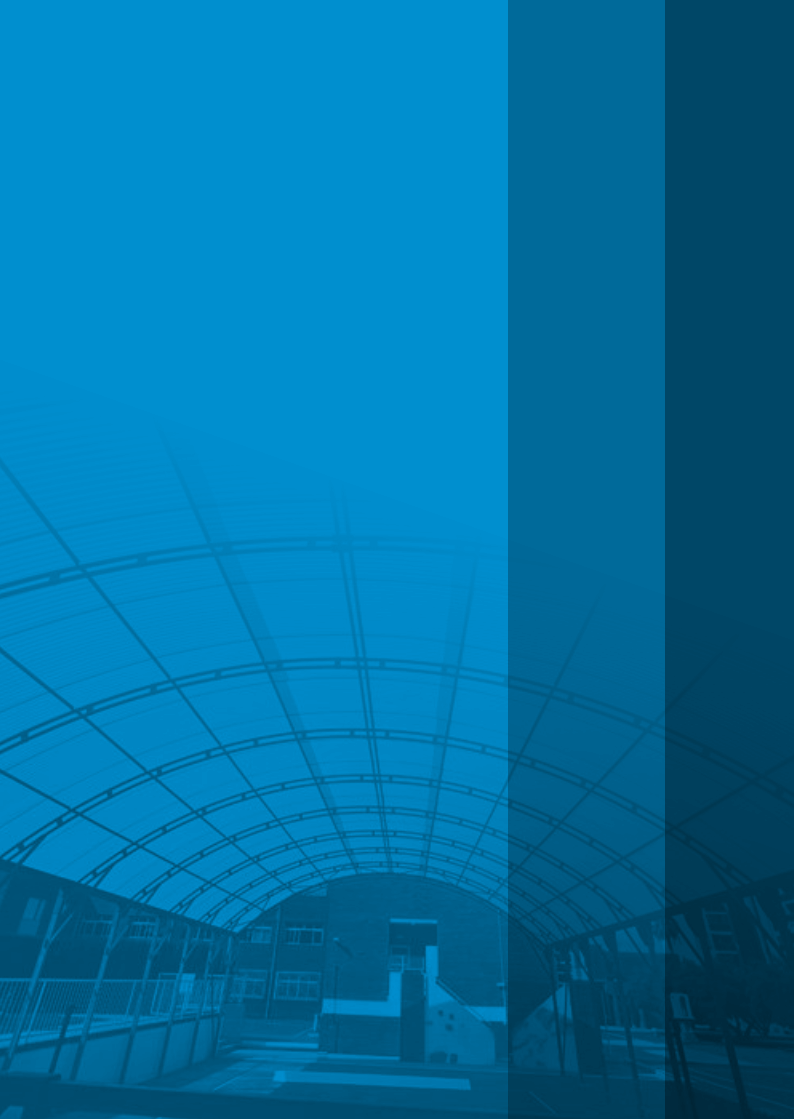

LUCERNARIOS

ALMACÉN BARCELONA

IRONLUX.COM





INFORMACIÓN IMPORTANTE PARA NUESTROS CLIENTES

DEBIDO A LOS CONTINUOS CAMBIOS EN
LOS COSTES DE LAS MATERIAS PRIMAS
POR LA INESTABILIDAD DEL MERCADO,
**NUESTROS PRECIOS* PUEDEN SUFRIR
ALTERACIONES.**

Informaremos de las actualizaciones vía
correo electrónico así como en nuestra WEB
www.ironlux.com

RECOMENDAMOS
REVISAR
LA VIGENCIA
DE LOS PRECIOS
A TRAVÉS
DE NUESTRA WEB.



TARIFA
ACTUALIZADA

*Los datos técnicos y precios serán válidos a partir
de la publicación de esta tarifa **salvo cambios en
el mercado o error tipográfico.**



POLICARBONATO CELULAR **ESTÁNDAR** Y ACCESORIOS

POLICARBONATO CELULAR ESTÁNDAR
ACCESORIOS DE POLICARBONATO

SOPLADO Y ENCINTADO DE PLACAS: **5,00 €/ml*** | MÁXIMO: 4000MM
TERMOSELLADO: **5,00 €/ud*** (ANCHO MÁXIMO: 1050 mm.) | (CONSULTAR CONDICIONES Y PLAZOS)

*PRECIOS NETOS



POLICARBONATO CELULAR ESTÁNDAR

POLICARBONATO CELULAR 6MM  PESO REAL: 1,3 kg/m²

CÓDIGO: 0078



STOCK

3,50 W/M2K	18 dB	LONGITUDES 3000 - 6000 mm (Dirección de aguas)	ANCHO ÚTIL 2100 mm	
Transmisión de luz: INCOLORO 82% - OPAL 58%		ESPESOR	COLOR	PRECIO €/M ²
PROTECCIÓN UV 2 CARAS		6mm	INCOLORO (TRANSPARENTE)	17,15
80KG Dist. máx. 510 mm.			HIELO (TRANSLÚCIDO)	18,20
 Bs1d0				

POLICARBONATO CELULAR 10MM  PESO REAL: 1,7 kg/m²

CÓDIGO: 0080

STOCK



2,70 W/M2K	19 dB	LONGITUDES 2000 - 3000 - 4000 - 5000* - 6000 - 7000 mm (Dirección de aguas)	ANCHO ÚTIL 1200-2100 mm	
Transmisión de luz: INCOLORO 81% - OPAL 48%		ESPESOR	COLOR	PRECIO €/M ²
PROTECCIÓN UV 2 CARAS		10mm	INCOLORO (TRANSPARENTE)	22,45
80KG Dist. máx. 700 mm.			HIELO (TRANSLÚCIDO)	23,75
 Bs1d0				

*5000 x 2100 mm. SÓLO EN INCOLORO

POLICARBONATO CELULAR 16MM - 3 PAREDES  PESO REAL: 2,7 kg/m²

CÓDIGO: 0081

STOCK

2,40 W/M2K	21 dB	LONGITUDES 2000 - 3000 - 4000 - 6000 - 7000 mm (Dirección de aguas)	ANCHO ÚTIL 1200-2100 mm	
Transmisión de luz: INCOLORO 76% - OPAL 48%		ESPESOR	COLOR	PRECIO €/M ²
PROTECCIÓN UV 2 CARAS		16mm	INCOLORO (TRANSPARENTE)	35,65
80KG Dist. máx. 1000 mm.			HIELO (TRANSLÚCIDO)	37,75
 Bs1d0				

3 PAREDES

POLICARBONATO CELULAR ESTÁNDAR

POLICARBONATO CELULAR 25MM  PESO REAL: 3 kg/m²

CÓDIGO: 0082



STOCK

1,40 W/M2K	23 dB	LONGITUDES → 3000 - 6000 mm (Dirección de aguas)	ANCHO ÚTIL → 2095 mm		
Transmisión de luz: INCOLORO 51% OPAL 44%			ESPESOR	COLOR	PRECIO €/M ²
PROTECCIÓN UV 2 CARAS			25mm	INCOLORO (TRANSPARENTE)	42,50
80KG Dist. máx. 1250 mm.		HIELO (TRANSLÚCIDO)		45,00	
 Bs1d0					

POLICARBONATO CELULAR 32MM  PESO REAL: 3,7 kg/m²

CÓDIGO: 0083

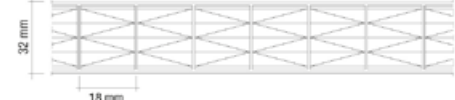
BAJO PEDIDO

1,10 W/M2K	23 dB	LONGITUDES → 3000 - 3500 - 4000 - 4500 - 7000 mm	ANCHO ÚTIL → 1200 mm		
Transmisión de luz: INCOLORO 38% OPAL 20%			ESPESOR	COLOR	PRECIO €/M ²
PROTECCIÓN UV 2 CARAS			32mm	INCOLORO (TRANSPARENTE)	54,35
80KG Dist. máx. 1250 mm.		HIELO (TRANSLÚCIDO)		57,50	
 Bs2d0					

POLICARBONATO CELULAR ESTÁNDAR

CÓDIGO: 0040

Perfil TAPETA Aluminio		ACABADO	€/ML
		ANODIZADO PLATA	5,30
MEDIDAS 3.000 - 6.000 MM.			
Perfil Universal Aluminio		ACABADO	€/ML
		ANODIZADO PLATA	7,80
MEDIDAS 3.000 - 6.000 MM.			
Goma UÑA Aleta		€/ROLLO	€/ML
		132,00	1,15
MEDIDAS ROLLO: 120 ML TAMBIEN POR ML.			
Goma BASE Estándar		€/ROLLO	€/ML
		171,00	2,95
MEDIDAS ROLLO: 60 ML TAMBIEN POR ML.			
Perfil Cierre en U Policarbonato (Protección UV 1 cara)		ESPESOR (mm.)	€/ML
		6	1,25
		10	1,40
		16	2,00
		25	3,35
MEDIDAS 2.100 MM.			

Perfil Unión en H Policarbonato (Protección UV 2 caras)*		ESPESOR (mm.)	€/ML
		6	3,05
		10	4,05
		16	6,50
		16 OPAL*	7,55
25	9,15		
MEDIDAS 3.000 - 6.000 MM.			
Tapón Polipropileno		ESPESOR (mm.)	€/UD
		6	1,00
		10	
16			
UNIVERSAL			
CONJUNTO TAPÓN+JUNTA+FIJACIÓN			
GM Sombrero Aluminio		ACABADO	€/UD
		ANODIZADO PLATA	1,00
UNIDAD NO INCLUYE ARAÑDELA NI CIERRE			
Cinta Aluminio Microperforada		ANCHO (mm.)	€/UD
		25 (8-10mm.)	20,15
		38 (16mm.)	31,70
		60 (25mm.)	47,75
UNIDAD ROLLO: 33 ML			
Cinta Aluminio Ciega		ANCHO (mm.)	€/UD
		25 (8-10mm.)	5,40
		38 (16mm.)	10,60
		60 (25mm.)	12,10
UNIDAD ROLLO: 50 ML			
Cumbrera de Acero (Blanco Pirineo)		€/UD	
		16,40	
UNIDAD 3.000 MM.			

► PERFIL UNIVERSAL DE ALUMINIO

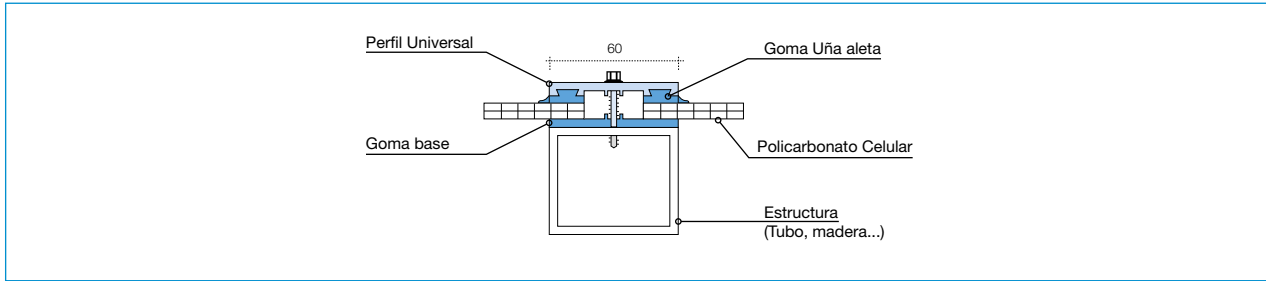

► INSTALACIÓN CON PERFILERÍA PLÁSTICA

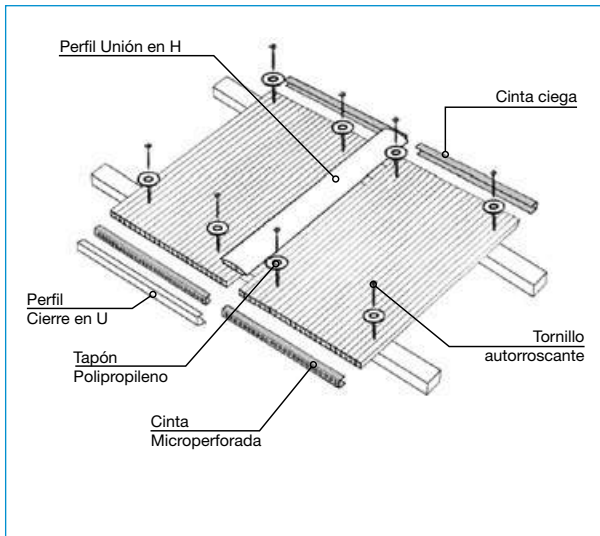

► ORIENTACIÓN DE LAS PLACAS

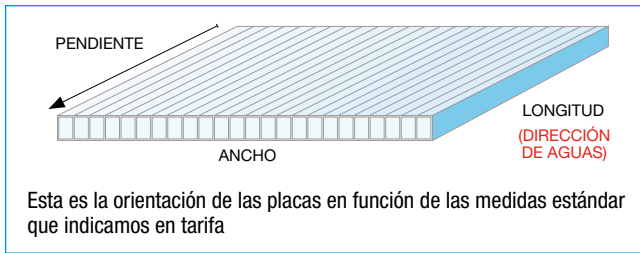

► CÁLCULO PARA INSTALACIONES EN CURVO

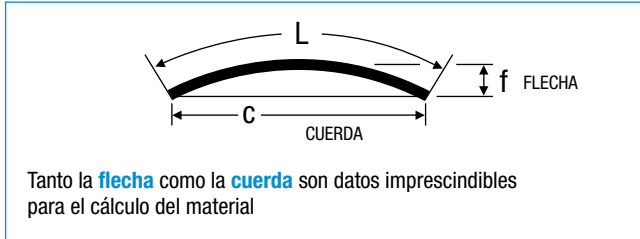



SISTEMAS POLICARBONATO CELULAR Y ACCESORIOS

POLICARBONATO CELULAR PERFILADO
POLICARBONATO PARA PANEL SANDWICH
POLICARBONATO CELULAR CURVO

POLICARBONATO CELULAR PERFILADO

BAJO PEDIDO

GM SISPOL GRECA 4



 Bs1d0

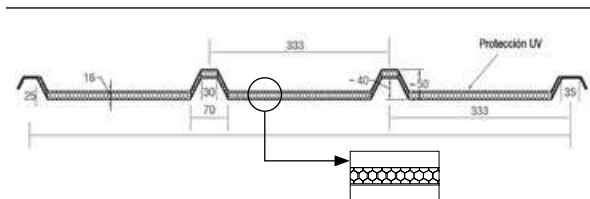

GM SISPOL GRECA 5

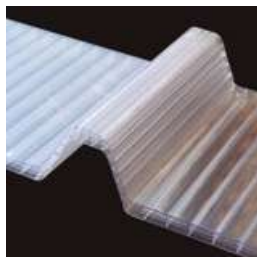

 Bs1d0

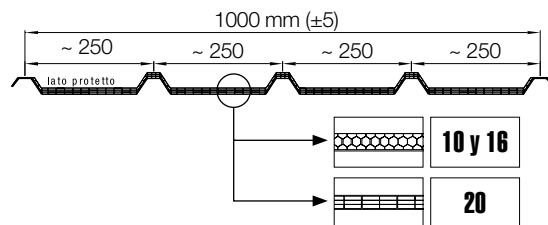

GM SISPOL MAXI GRECA

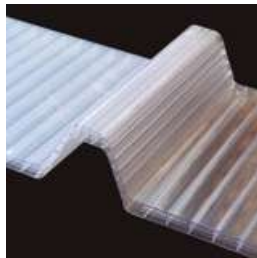

 Bs1d0

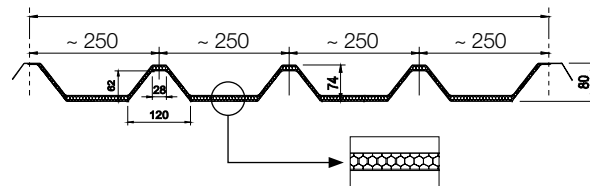

ESPESOR	COLOR	PRECIO €/M ²
10 mm	INCOLORO	34,90
	HIELO	36,90
16 mm	INCOLORO	41,95
	HIELO	44,30

ESPESOR	COLOR	PRECIO €/M ²
10 mm	INCOLORO	32,20
	HIELO	34,10
16 mm	INCOLORO	39,30
	HIELO	41,60
20 mm	INCOLORO	47,50
	HIELO	50,20

ESPESOR	COLOR	PRECIO €/M ²
12 mm	INCOLORO	38,10
	HIELO	40,30
16 mm	INCOLORO	43,60
	HIELO	46,10
20 mm	INCOLORO	53,30
	HIELO	56,50

POLICARBONATO PANEL SANDWICH

GM SISPOL 30MM MULTIPANEL (1000)

CÓDIGO: 0023

STOCK

		LONGITUDES 4000 - 5000 - 6000 - 8000 - 10000 - 12000 mm	ANCHO ÚTIL 1000 mm		
w/m²K: 1,25			ESPESOR	COLOR	PRECIO €/M²
LT= 39%			30 mm	HIELO (TRANSLÚCIDO)	43,95
Bs1d0	Posibilidad en 40 y 50 mm. (Consultar disponibilidad)		40 HIELO	48,50	50 HIELO 50,20

GM SISPOL 30MM MULTIPANEL (1150)

CÓDIGO: 0144

STOCK

		LONGITUDES 4000 - 5000 - 8000 - 10000 mm	ANCHO ÚTIL 1150 mm		
w/m²K: 1,25			ESPESOR	COLOR	PRECIO €/M²
LT= 39%			30 mm	HIELO (TRANSLÚCIDO)	43,95
Bs1d0					

ACCESORIOS (PIEZAS DE UNIÓN DE ACERO)

TAPETA UNIÓN			
€/ML.	5,00	€/ud.	3,40
Precio por el conjunto (opción correcta según fabricante)			

POLICARBONATO PANEL SANDWICH

STOCK

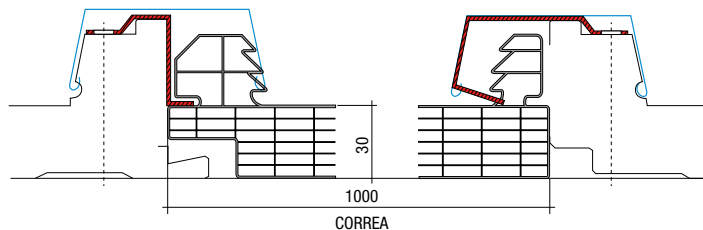

SISTEMA DE UNIÓN COMPATIBLE
CON PANELES **ITALPANNELLI**

STOCK

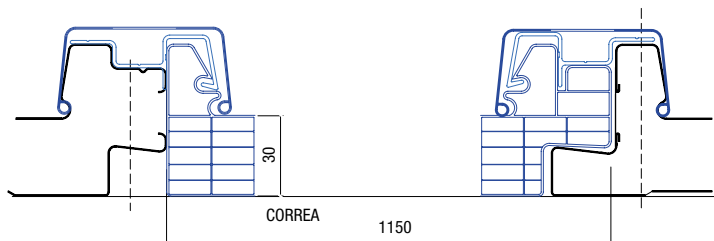

SISTEMA DE UNIÓN COMPATIBLE
CON PANELES **ARCELOR** Y **EUROPERFIL**

BAJO PEDIDO

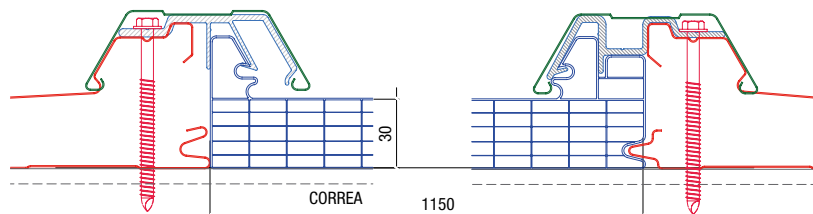

SISTEMA DE UNIÓN COMPATIBLE
CON PANELES **HUURRE** Y **TECZONE**

POLICARBONATO PANEL SANDWICH

GM SISPOL "GRECA LLENA"

CÓDIGO: 0158 BAJO PEDIDO

LONGITUDES BAJO PEDIDO

ANCHO ÚTIL 1000 mm

w/m ² K: 1,1
TRANSMISIÓN DE LUZ: 39%
 Bs1d0

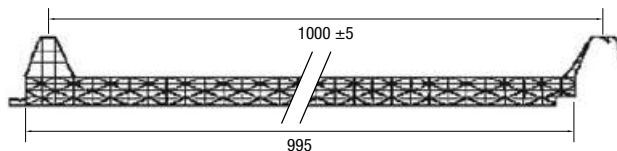

ESPESOR	COLOR	PRECIO €/M ²
30mm	HIELO (TRANSLÚCIDO)	45,95
40mm		47,50



OTROS SISTEMAS, FORMATOS Y ESPESORES, CONSULTAR.

SISTEMA POLICARBONATO CURVO

POLICARBONATO CELULAR CURVO 16MM

CÓDIGO: 0173

STOCK

2,00 W/M2K 21 dB

LONGITUDES 6000 mm

ANCHO ÚTIL = <1067 mm

Transmisión de luz:
INCOLORO 67%
OPAL 63%

PROTECCIÓN UV
1 CARA (EXTERIOR)

AISLAMIENTO
ACÚSTICO: 19 DB



ESPESOR	COLOR	PRECIO €/M ²
16mm	HIELO (TRANSLÚCIDO)	46,20

Sistema de lucernario para cubierta. Fabricado en policarbonato celular de **16 mm.** de espesor, **curvado.**

Este permite realizar claraboyas abovedadas y puede adaptarse a huecos ya existentes de diferentes anchos (máximo, 1067 mm.)

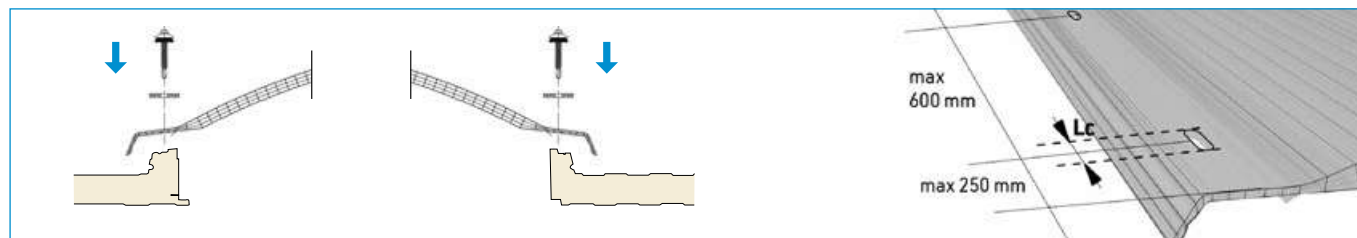
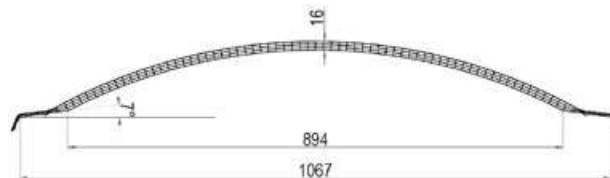

DATOS TÉCNICOS



Material: Policarbonato celular de 4 paredes. **Longitud:** 6000 mm.
Coefficiente de dilatación térmica lineal: $6,5 \times 10^{-5} \text{ K}^{-1}$ (0,065 mm/,°C).

Espesor: 16 mm. **Temperatura de servicio:** -30°C / +120°C.
Ancho máximo: 1.067 mm.

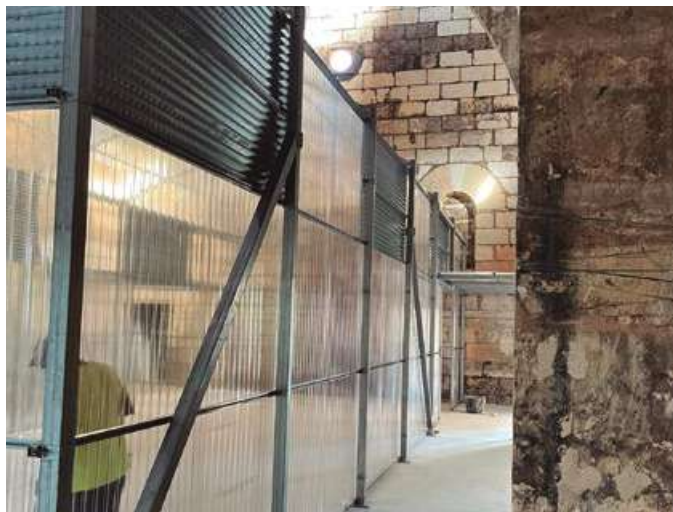

POLICARBONATO COMPACTO CORRUGADO



POLICARBONATO COMPACTO CORRUGADO

POLICARBONATO COMPACTO CORRUGADO

GARANTÍA 10 AÑOS

POLICARBONATO GRAN ONDA - 0,9 MM.

CÓDIGO: 0163

STOCK

INCOLORO **LONGITUDES** 2000 - 2500 - 3000 mm **HIELO** **LONGITUDES** 2500 - 3000 mm **ANCHO** 1100 mm

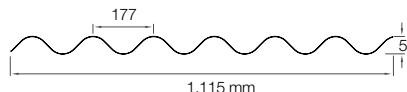

Bs1d0 **ONDA GRANDE**

COLOR	PRECIO €/M ²
INCOLORO (TRANSPARENTE)	16,25
HIELO (TRANSLÚCIDO)	16,85

POLICARBONATO MINIONDA - 0,8 MM.

CÓDIGO: 0021

STOCK

INCOLORO **LONGITUDES** 2000 - 2500 - 3000 mm **HIELO** **LONGITUDES** 2500 - 3000 mm **ANCHO** 1270 mm

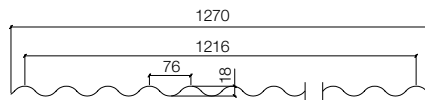
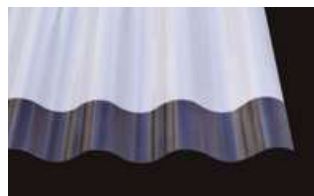

Bs1d0 **MINIONDA**

COLOR	PRECIO €/M ²
INCOLORO (TRANSPARENTE)	13,80
HIELO (TRANSLÚCIDO)	14,30

POLICARBONATO TRAPEICIAL - 0,9 MM. - PERFIL 30/210

CÓDIGO: 0164

STOCK

INCOLORO **LONGITUDES** 3000 - 6000 mm **HIELO** **LONGITUDES** 3000 - 6000 mm **ANCHO** 1100 mm

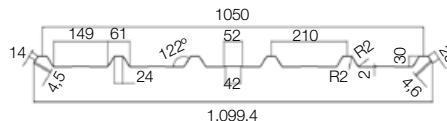

Bs1d0 **30/210/1100**

COLOR	PRECIO €/M ²
INCOLORO (TRANSPARENTE)	15,90
HIELO (TRANSLÚCIDO)	16,50

POLICARBONATO COMPACTO CORRUGADO

POLICARBONATO TRAPEZIAL - 0,9 MM. - PERFIL 30/206

CÓDIGO: 0166 STOCK

INCOLORO **LONGITUDES** 3000 - 6000 mm **HIELO** **LONGITUDES** 3000 - 6000 mm **ANCHO** 1110 mm

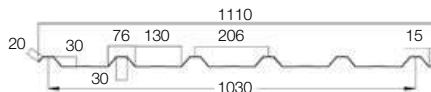

BS1d0 30/206/1110

COLOR	PRECIO €/M ²
INCOLORO (TRANSPARENTE)	15,90
HIELO (TRANSLÚCIDO)	16,50

POLICARBONATO TRAPEZIAL - 0,9 MM. - PERFIL 40/250

CÓDIGO: 0167 STOCK

INCOLORO **LONGITUDES** 3000 - 6000 mm **HIELO** **LONGITUDES** 3000 - 6000 mm **ANCHO** 1088 mm

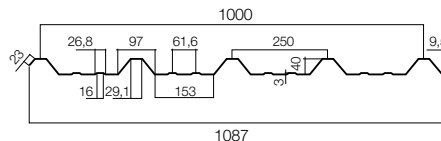

BS1d0 40/250/1088

COLOR	PRECIO €/M ²
INCOLORO (TRANSPARENTE)	16,20
HIELO (TRANSLÚCIDO)	16,80

POLICARBONATO TRAPEZIAL - 0,9 MM. - PERFIL 32/200

CÓDIGO: 0165 BAJO PEDIDO

LONGITUDES A CONSULTAR **ANCHO** 1093 mm

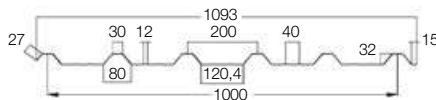

BS1d0 32/200/1093

COLOR	PRECIO €/M ²
INCOLORO (TRANSPARENTE)	15,90
HIELO (TRANSLÚCIDO)	16,50

POLICARBONATO COMPACTO CORRUGADO

OTRAS OPCIONES DE PERFIL

BAJO CONSULTA

PERFIL GRECA 76/18

Anchos: 660 - 810 - 1040 - 1064 - 1260 - 1870



PERFIL OMEGA

Anchos: 1260 - 1870

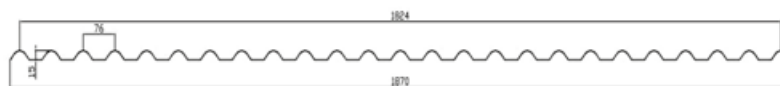

PERFIL 30/208

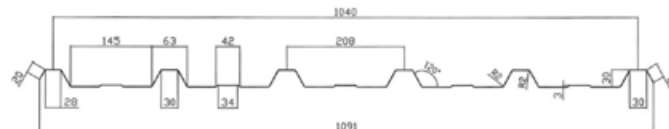

PERFIL 30/209

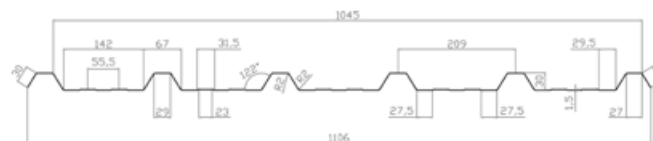

PERFIL TZ-30

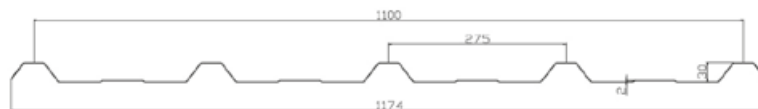

POLICARBONATO COMPACTO CORRUGADO

OTRAS OPCIONES DE PERFIL

BAJO CONSULTA

PERFIL
MT-42



PERFIL
44/333,3

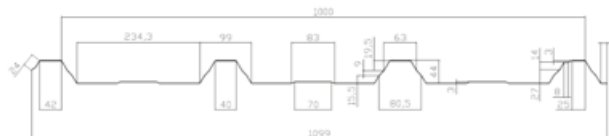

PERFIL
46/250

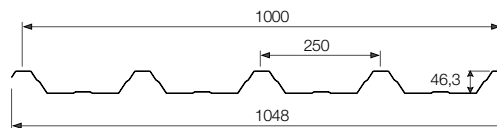

PERFIL
MT-52

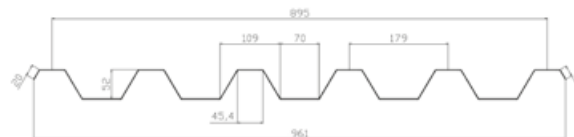

CONSULTAR DISPONIBILIDAD Y MEDIDAS

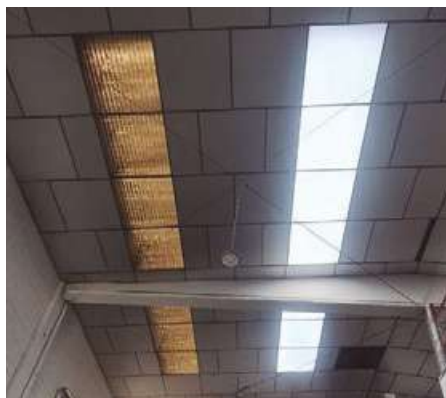



POLICARBONATO Y METACRILATO **COMPACTOS, CLARABOYAS, Y VENTANAS PARA CUBIERTA**

POLICARBONATO Y METACRILATO COMPACTOS
CLARABOYAS
VENTANAS PARA CUBIERTA
ACCESORIOS

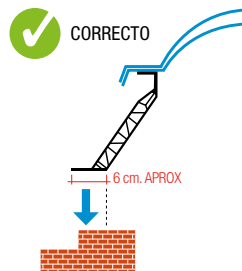
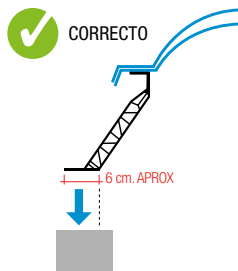
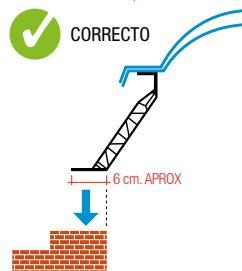
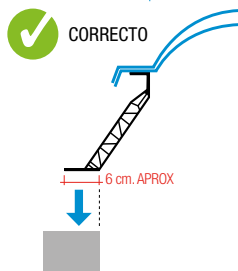
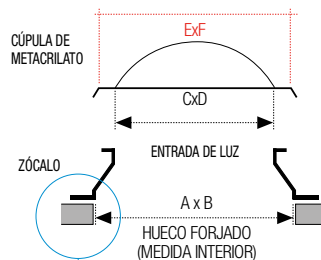

POLICARBONATO Y METACRILATO COMPACTOS

POLICARBONATO COMPACTO

CÓDIGO: 0028 **BAJO PEDIDO**

MEDIDAS ESTÁNDAR 3050 x 2030 mm. Otros espesores y colores, consultar.



Bs1d0

**GARANTÍA
10 AÑOS**



ESPESOR (mm.)	COLOR	PRECIO €/M ²	ESPESOR (mm.)	COLOR	PRECIO €/M ²
3	INCOLORO	47,95	6	INCOLORO	95,80
	OPAL	50,30			
4	INCOLORO	63,90	8	INCOLORO	127,70
	OPAL	67,10			
5	INCOLORO	79,85	10	INCOLORO	159,65

METACRILATO - COLADA

CÓDIGO: 0029 **BAJO PEDIDO**

MEDIDAS ESTÁNDAR 3050 x 2030 mm. Otros espesores y colores, consultar.

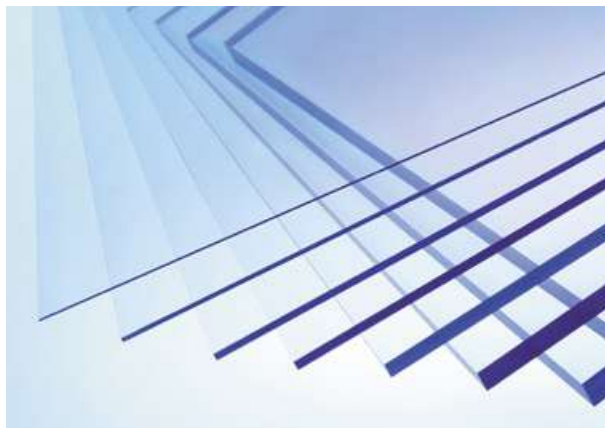

ESPESOR (mm.)	COLOR	PRECIO €/M ²	ESPESOR (mm.)	COLOR	PRECIO €/M ²
3	INCOLORO	52,10	6	INCOLORO	94,70
	HIELO	54,70		HIELO	99,45
	COLOR	62,80			
4	INCOLORO	66,30	8	INCOLORO	126,25
	HIELO	69,60		HIELO	132,55
5	INCOLORO	78,95	10	INCOLORO	157,80
	HIELO	82,85		HIELO	170,70

CLARABOYAS (METACRILATO)

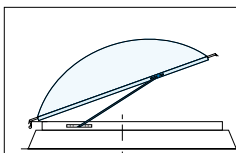
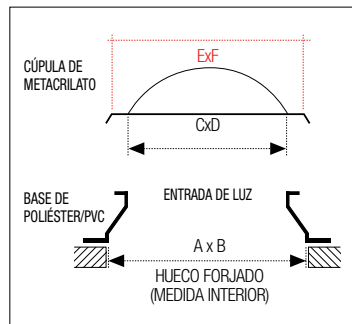

ACCESO

Indicada para acceder a la cubierta.
Apertura total. (85°)

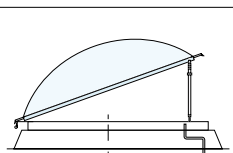

HUSILLO

Mecanismo accionado mediante manivela (no incluida).
Apertura parcial. (30 cm)

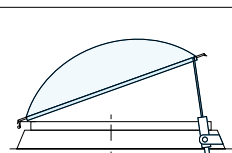

ELÉCTRICA

Opciones:
1- Interruptor
2- Mando
Apertura parcial. (30 cm)

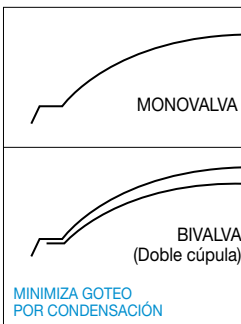

BAJO PEDIDO

CUADRADAS

HUECO FORJADO Medida (AxB) en cm.	ENTRADA LUZ Medida (CxD) en cm.	(ExF)	Cúpulas sueleltas	CLARABOYAS FIJAS ZÓCALO + CÚPULA		CLARABOYAS CON SISTEMA DE APERTURA										PORTES FÁBRICA
				Monovalva	Bivalva	APERTURA HUSILLO		APERTURA ACCESO		APERTURA ELÉCTRICA		A. ELÉCTRICA MANDO		AP.MIXTA (HUS+ELEC)		
						Monovalva	Bivalva	Monovalva	Bivalva	Monovalva	Bivalva	Monovalva	Bivalva	Monovalva	Bivalva	
50 X 50	30x30	44x44	42,00	100,00	141,00	189,00	231,00	***	***	453,00	493,00	625,00	665,00	732,00	766,00	LADO HASTA 80 cm
60 X 60	40x40	54x54	48,00	113,00	160,00	202,00	250,00	191,00	239,00	462,00	507,00	634,00	679,00	743,00	783,00	LADO HASTA 120 cm
70 X 70	50x50	64x64	56,00	122,00	178,00	227,00	282,00	225,00	280,00	480,00	532,00	652,00	704,00	753,00	800,00	LADO HASTA 150 cm
70 X 70 (TEJA)	50x50	64x64	56,00	122,00	178,00	368,00	412,00	357,00	400,00	601,00	643,00	831,00	873,00	***	***	LADO HASTA 200 cm
80 X 80	60x60	74x74	67,00	143,00	210,00	258,00	324,00	258,00	324,00	498,00	561,00	670,00	733,00	781,00	840,00	LADO HASTA 200 cm
90 X 90	70x70	84x84	79,00	155,00	233,00	296,00	374,00	271,00	349,00	516,00	590,00	688,00	762,00	810,00	879,00	LADO HASTA 200 cm
100 X 100	80x80	94x94	90,00	174,00	263,00	315,00	404,00	290,00	380,00	534,00	619,00	706,00	791,00	820,00	894,00	LADO HASTA 200 cm
110 X 110	90x90	104x104	111,00	206,00	317,00	359,00	469,00	345,00	456,00	561,00	666,00	733,00	838,00	886,00	983,00	LADO HASTA 200 cm
120 X 120	100x100	114x114	126,00	227,00	353,00	381,00	507,00	380,00	505,00	580,00	699,00	751,00	871,00	905,00	1.018,00	LADO HASTA 200 cm
130 X 130	110x110	124x124	157,00	258,00	414,00	420,00	576,00	433,00	589,00	616,00	764,00	788,00	936,00	***	***	LADO SUPERIOR A 200 cm
140 X 140	120x120	134x134	181,00	296,00	477,00	458,00	639,00	484,00	665,00	688,00	860,00	860,00	1.032,00	***	***	LADO SUPERIOR A 200 cm
150 X 150	130x130	144x144	227,00	355,00	581,00	524,00	751,00	496,00	722,00	797,00	1.012,00	969,00	1.184,00	***	***	LADO SUPERIOR A 200 cm
160 X 160	140x140	154x154	275,00	395,00	669,00	570,00	844,00	534,00	808,00	860,00	1.121,00	1.032,00	1.292,00	***	***	LADO SUPERIOR A 200 cm
170 X 170	150x150	164x164	334,00	458,00	791,00	772,00	1.105,00	***	***	914,00	1.231,00	1.086,00	1.403,00	***	***	LADO SUPERIOR A 200 cm
180 X 180	160x160	174x174	353,00	469,00	821,00	810,00	1.162,00	***	***	1.005,00	1.340,00	1.177,00	1.511,00	***	***	LADO SUPERIOR A 200 cm
200 X 200	180x180	194x194	374,00	517,00	890,00	943,00	1.317,00	***	***	1.041,00	1.396,00	1.213,00	1.568,00	***	***	LADO SUPERIOR A 200 cm

SUMAR AL COSTE DE LA CLARABOYA

STOCK

ENTRE 10 Y 20 DÍAS LABORABLES (SEGÚN MEDIDAS)

CLARABOYAS (METACRILATO)

BAJO PEDIDO		RECTANGULARES															
HUECO FORJADO Medida (AxB) en cm.	ENTRADA LUZ Medida (CxD) en cm.	(ExF)	Cúpulas sueltas	CLARABOYAS FIJAS ZÓCALO + CÚPULA		CLARABOYAS CON SISTEMA DE APERTURA										PORTES FÁBRICA	
				Monovalva	Bivalva	APERTURA HUSILLO		APERTURA ACCESO		APERTURA ELÉCTRICA		A. ELÉCTRICA MANDO		AP.MIXTA (HUS+ELEC)			
						Monovalva	Bivalva	Monovalva	Bivalva	Monovalva	Bivalva	Monovalva	Bivalva	Monovalva	Bivalva		
50 X 100	30 X 80	44x94	54,00	124,00	178,00	237,00	290,00	216,00	269,00	471,00	522,00	643,00	694,00	670,00	721,00	LADO HASTA 80 cm	35 €
60 X 80	40 X 60	54x74	60,00	128,00	187,00	252,00	311,00	239,00	298,00	480,00	536,00	652,00	708,00	688,00	744,00	LADO HASTA 120 cm	50 €
60 X 90	40 X 70	54x84	65,00	136,00	200,00	256,00	320,00	218,00	282,00	489,00	551,00	661,00	722,00	706,00	768,00	LADO HASTA 150 cm	75 €
60 X 100	40 X 80	54x94	77,00	151,00	227,00	265,00	341,00	246,00	322,00	498,00	570,00	670,00	742,00	715,00	788,00	LADO HASTA 200 cm	100 €
60 X 120	40 X 100	54x114	92,00	183,00	275,00	322,00	414,00	303,00	395,00	507,00	594,00	679,00	766,00	733,00	820,00	LADO SUPERIOR A 200 cm	200 €
60 X 200	40 X 180	54x194	140,00	239,00	378,00	551,00	690,00	399,00	538,00	634,00	766,00	806,00	938,00	***	***	ACCESORIOS	12 €
70 X 100	50 X 80	64x94	82,00	160,00	242,00	279,00	360,00	265,00	347,00	507,00	585,00	679,00	757,00	724,00	802,00	SUMAR AL COSTE DE LA CLARABOYA	
76 X 156	56 X 136	70x150	162,00	258,00	420,00	450,00	612,00	416,00	578,00	652,00	806,00	824,00	978,00	815,00	969,00		
80 X 100	60 X 80	74x94	88,00	189,00	277,00	298,00	385,00	290,00	378,00	516,00	599,00	688,00	771,00	742,00	826,00		
80 X 110	60 X 90	74x104	94,00	199,00	292,00	313,00	406,00	301,00	395,00	543,00	632,00	715,00	804,00	760,00	849,00		
80 X 120	60 X 100	74x114	107,00	210,00	317,00	340,00	446,00	332,00	439,00	580,00	681,00	751,00	853,00	779,00	880,00		
80 X 140	60 X 120	74x134	117,00	248,00	364,00	380,00	496,00	380,00	496,00	607,00	717,00	779,00	889,00	815,00	925,00		
90 X120	70 X 100	84x114	113,00	239,00	351,00	374,00	486,00	372,00	484,00	607,00	713,00	779,00	885,00	806,00	912,00		
94 X140	74 X 120	88x134	145,00	282,00	427,00	427,00	572,00	416,00	560,00	670,00	808,00	842,00	979,00	***	***		
100 X 150	80 X 130	94x144	159,00	284,00	442,00	444,00	602,00	437,00	595,00	652,00	802,00	824,00	974,00	***	***		
100 X 200	80 X 180	94x194	223,00	353,00	576,00	547,00	770,00	534,00	757,00	779,00	990,00	950,00	1.162,00	***	***		
114 X 174	94 X 154	108x168	252,00	448,00	700,00	660,00	911,00	***	***	887,00	1.126,00	1.059,00	1.298,00				
150 X 200	130 X 180	144x194	305,00	486,00	791,00	840,00	1.145,00	***	***	1.195,00	1.484,00	1.367,00	1.656,00	***	***		
150 X 300	130 X 280	144x294	543,00	905,00	1.448,00	1.220,00	1.762,00	***	***	1.358,00	1.873,00	1.530,00	2.045,00	***	***		
160 X 240	140 X 220	154x234	524,00	867,00	1.391,00	1.210,00	1.734,00	***	***	1.303,00	1.801,00	1.475,00	1.973,00	***	***		
200 X 260	180 X 240	194x254	543,00	877,00	1.420,00	1.210,00	1.753,00	***	***	1.303,00	1.819,00	1.475,00	1.991,00	***	***		
200 X 300	180 X 280	194x294	570,00	924,00	1.494,00	1.227,00	1.797,00	***	***	1.358,00	1.899,00	1.530,00	2.071,00	***	***		

CLARABOYAS (METACRILATO)

BAJO PEDIDO		CIRCULARES											
HUECO FORJADO Medida (AxB) en cm. ø	ENTRADA LUZ Medida (Cx D) en cm. ø	(ExF)	Cúpulas sueitas	CLARABOYAS FIJAS ZÓCALO + CÚPULA		CLARABOYAS CON SISTEMA DE APERTURA							
				Monovalva	Bivalva	APERTURA HUSILLO		APERTURA ACCESO		APERTURA ELÉCTRICA		A. ELÉCTRICA MANDO	
						Monovalva	Bivalva	Monovalva	Bivalva	Monovalva	Bivalva	Monovalva	Bivalva
60	40	54	50,00	120,00	170,00	303,00	353,00	***	***	641,00	677,00	909,00	945,00
70	50	64	58,00	130,00	187,00	341,00	399,00	***	***	648,00	692,00	923,00	967,00
80	60	74	69,00	149,00	218,00	387,00	456,00	***	***	677,00	732,00	947,00	1.001,00
90	70	84	80,00	166,00	246,00	444,00	524,00	***	***	697,00	784,00	960,00	1.046,00
100	80	94	92,00	183,00	275,00	473,00	564,00	***	***	706,00	775,00	974,00	1.043,00
110	90	104	113,00	221,00	334,00	572,00	684,00	***	***	760,00	876,00	1.010,00	1.126,00
120	100	114	128,00	239,00	366,00	***	***	***	***	***	***	***	***
130	110	124	159,00	275,00	433,00	***	***	***	***	***	***	***	***
140	120	134	183,00	315,00	498,00	***	***	***	***	***	***	***	***
150	130	144	229,00	372,00	600,00	***	***	***	***	***	***	***	***
180	160	174	357,00	553,00	909,00	***	***	***	***	***	***	***	***
200	180	194	380,00	562,00	941,00	***	***	***	***	***	***	***	***

Manivela lacada blanco de 1,5 m.	38 €/u.	Motor eléctrico de 180mm. de recorrido	38 €/u.	Husillo simple para claraboya	38 €/u.
Sensor de lluvia*	38 €/u.	Sensor de lluvia y viento*	38 €/u.	*Únicamente en claraboyas eléctricas con mando	

PORTES FÁBRICA
LADO HASTA 80 cm
35 €
LADO HASTA 120 cm
50 €
LADO HASTA 150 cm
75 €
LADO HASTA 200 cm
100 €
LADO SUPERIOR A 200 cm
200 €
ACCESORIOS
12 €
SUMAR AL COSTE DE LA CLARABOYA

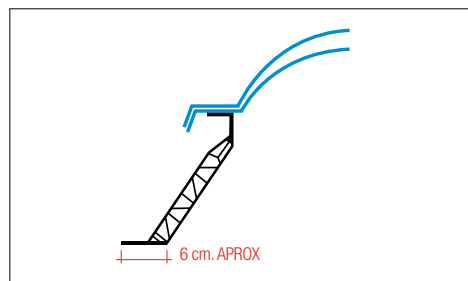

ZÓCALO en POLIÉSTER/PVC con cámara de aire.
CÚPULA en METACRILATO.



Claraboya **FIJA** con clasificación de **reacción al fuego Bs1d0** según norma UNE-EN 13501-1:2007 + A1:2010.

Compuestas por una cúpula de policarbonato celular y un zócalo de chapa de acero prelacada en blanco de 1,5mm de espesor y con un aislamiento exterior en color gris pizarra.

CÚPULA POLICARBONATO. ZÓCALO CHAPA

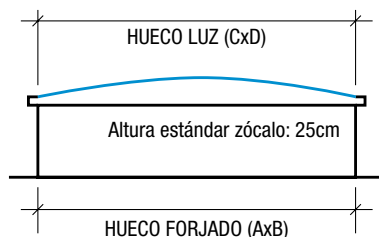

Medida A x B (mm.)	€/ud.	Material cúpula Policarbonato celular 10 mm color opal Material zócalo Chapa de acero prelacada en blanco. 1,5 mm de espesor. Resistencia al fuego Bs1d0 Apertura FIJA	Transmisión térmica: 3,02 W/m2K Transmisión de luz: 64% Aislamiento acústico: 19dB
1.000 x 1.000	1130,00 €		
1.000 x 1.500	1305,00 €		
1.500 x 1.500	1615,00 €		
2.000 x 2.000	1880,00 €		

Posibilidad de fabricar A MEDIDA (Consultar) / opciones de EXUTORIOS en nuestra web www.ironlux.com



APERTURAS
FIJA (Sin apertura)
ACCESO A CUBIERTA
HUSILLO
ELÉCTRICA (interruptor)
ELÉCTRICA (mando)

Las ventanas para cubierta plana de **Indalolux**, permiten la entrada de luz natural en hogares y edificios con cubierta plana (de hasta el *8% de inclinación*).

Sobre un zócalo de PVC aislado mediante cámara de aire, la parte superior está compuesta por **vidrio de baja emisividad** y periferia de aluminio (propiedades técnicas según familia: GMI glass o GMI COMFORT)

CARACTERÍSTICAS DE LA VENTANA	
Perfil de Aluminio	Doble lacado Antracita RAL 7016 / Interior Blanco
Disposición del Cristal	Desbordante
CARACTERÍSTICAS DEL VIDRIO	
Estructura Triple Acristalamiento	Ext. 5mm. Control Solar - Int. 4+4mm. + TPS 14mm.
Gas	ARGÓN
Vidrio exterior templado	SÍ
Baja emisividad	SÍ
Transmisión térmica U [(W/m2K)]	1,0
Transmisión total de energía solar: g	62,80%
Transmisión luminosa tv	80,50%
Aislamiento acústico [dB]	35
Resistencia al impacto	2(B)2
Resistencia al choque	P2A

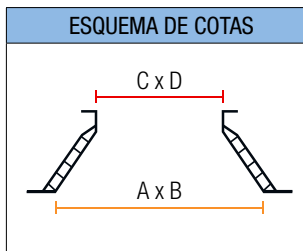



PORTES DE FÁBRICA (SUMAR AL COSTE DE LA VENTANA)	
LADO HASTA 80 cm	LADO HASTA 200 cm
35 €	100 €
LADO HASTA 120 cm	LADO SUPERIOR A 200 cm
50 €	200 €
LADO HASTA 150 cm	ACCESORIOS
75 €	12 €

CUADRADAS						
HUECO FORJADO Medida (AxB) en cm. ø	ENTRADA LUZ Medida (CxD) en cm. ø					
		FIJAS	HUSILLO	ACCESO	ELÉCTRICA	ELÉCT. MANDO
50x50	30x30	700,00	900,00	X	980,00	1600,00
60x60	40x40	740,00	940,00		1020,00	1630,00
70x70	50x50	770,00	980,00		1050,00	1670,00
80x80	60x60	820,00	1020,00		1100,00	1720,00
90x90	70x70	880,00	1080,00	X	1160,00	1770,00
100x100	80x80	940,00	1140,00	X	1220,00	1830,00
110x110	90x90	1020,00	1230,00	X	1300,00	1920,00
120x120	100x100	1130,00	1340,00	X	1550,00	2160,00
130x130	110x110	1160,00	1370,00	X	1590,00	2200,00

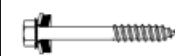

- Husillo doble en medidas: 60x200, 94x140, 130x130
- Dos motores sincronizados en medidas: 130x130, 60x200, 76x156, 94x140, 100x150
- Tres motores sincronizados en medidas: 100x200
- Posibilidad vidrio celeste opal + 5x
- Posibilidad fabricación a medida - Recargo 100€

RECTANGULARES						
HUECO FORJADO Medida (AxB) en cm. ø	ENTRADA LUZ Medida (CxD) en cm. ø					
		FIJAS	HUSILLO	ACCESO	ELÉCTRICA	ELÉCT. MANDO
50 X 100	30 X 80	850,00	1050,00	1030,00	1140,00	1750,00
60 X 80	40 X 60	830,00	1030,00	1010,00	1110,00	1730,00
60 X 90	40 X 70	850,00	1050,00	1030,00	1140,00	1750,00
60 X 100	40 X 80	920,00	1130,00	x	1210,00	1820,00
60 X 120	40 X 100	950,00	1150,00	x	1230,00	1840,00
60 X 200	40 X 180	1400,00	x	x	1820,00	2430,00
70 X 100	50 X 80	980,00	1180,00	x	1270,00	1880,00
76 X 156	56 X 136	1210,00	1410,00	x	1630,00	2250,00
80 X 100	60 X 80	1040,00	1240,00	x	1330,00	1940,00
80 X 110	60 X 90	1090,00	1290,00	x	1370,00	1990,00
80 X 120	60 X 100	1140,00	1340,00	x	1420,00	2030,00
80 X 140	60 X 120	1170,00	1370,00	x	1460,00	2070,00
90 X 120	70 X 100	1210,00	1410,00	x	1490,00	2100,00
94 X 140	74 X 120	1340,00	1660,00	x	1760,00	2380,00
100 X 150	80 X 130	1510,00	1830,00	x	1940,00	2550,00
100 X 200	80 X 180	1960,00	x	x	3020,00	3640,00

*Sensor de lluvia, incluido

TORNILLOS	Tornillo Zincado Autorroscante		ACABADO	MEDIDAS	€/UD	
			ZINCADO	6,3X25+P18	0,10	
				6,3X40+P18	0,16	
				6,3X60+P18	0,20	
				6,3X90+P18	0,30	
	6,3X110+P18	0,32				
	6,3X130+P18	0,38				
	LLAVE DE VASO	10	BROCA	4mm (DE 1A 2mm) / 5,05mm (DE 2 A 2,9mm)		
	Tornillo Zincado Autotaladrante (VIGA)		ACABADO	MEDIDAS	€/UD	
			ZINCADO	5,5X75XP16	0,40	
5,5X105+P16				0,55		
5,5X115+P16				0,65		
LLAVE DE VASO	8	CAPACIDAD DE TALADRO	ENTRE 4 Y 12mm			
Tornillo Teja		ACABADO	MEDIDAS	€/UD		
		8004	6,3X120+P25 EPDM-AR	0,80		
			6,3X120+P25 EPDM-AT			
		PIZARRA	6,3X120+P25 EPDM-AR	0,80		
			6,3X120+P25 EPDM-AT			
AR.: AUTORROSCANTE / AT.: AUTOTALADRANTE						
LLAVE DE VASO	10	BROCA	4mm (DE 1A 2mm) / 5,05mm (DE 2 A 2,9mm)			

ARANDELAS Y TAPONES	Arandelas		ACABADO	DESCRIPCIÓN	€/UD
			GALVA	P18 P25 Doble Estanq. Gran Onda Mini Onda	0,10 0,20 0,20 0,20
	Tapones		COLORES	CABEZA HEXAGONAL	0,12

TORNILLOS	Tornillo Zincado Autotaladrante		ACABADO	MEDIDAS	€/UD	
			ZINCADO	6,3X25+P18	0,10	
				6,3X40+P18	0,18	
				6,3X60+P18	0,22	
				6,3X90+P18	0,32	
	6,3X110+P18	0,34				
	6,3X130+P18	0,40				
	6,3X150+P18	0,55				
	LLAVE DE VASO	10	CAPACIDAD DE TALADRO	ENTRE 2 Y 6mm		
	Tornillo Hormigón		ACABADO	MEDIDAS	€/UD	
AZUL			6,5X32+P16	0,18		
			6,5X57+P16	0,20		
			6,5X100+P16	0,35		
			6,5X125+P16	0,45		
LLAVE DE VASO	8	FIJACIÓN MÍNIMA EN EL HORMIGÓN (MACIZO)	25mm			
Fijaciones Cosido Chapa		ACABADO	MEDIDAS	€/UD		
		BLANCO 8004	4,2X14 AT PLANA	0,12		
		8004 ROJO TEJA PLATA ARENA	TORNILLO "TOR"	0,22		
		8004 PIZARRA BLANCO	REMACHES	0,10		
		AR.: AUTORROSCANTE / AT.: AUTOTALADRANTE				

OTROS		DESCRIPCIÓN	€/UD
		GANCHO DE FIJACIÓN 52X150MM	0,50
		SOPORTE DE ONDA POLIPROPILENO ONDA GRANDE	0,35
		SOPORTE DE ONDA POLIPROPILENO MINI ONDA	0,25
		SOPORTE DE ONDA POLIPROPILENO ONDA GRECA	0,35
		SOPORTE CANALÓN CUBIERTA 30MM	1,20
		SOPORTE CANALÓN CUBIERTA 50MM	1,40
GRAPA TORNILLERÍA OCULTA	0,60		

www.ironlux.com

IRONLUX BARCELONA

Pol. Ind. La Ferrería
c/ Progrès, 55 (esquina Química)
08110 Montcada i Reixac
Barcelona

Tel: 935 751 510

 **629 34 96 10** (únicamente para Whatsapp)

Horarios:

Tienda y Atención al Cliente

De lunes a jueves de 7 a 17.30h.

Viernes de 7 a 15h.

Almacén y pedidos

De lunes a jueves de 7 a 13.30h y de 15 a 17.30h.

Viernes de 7 a 15h.

IRONLUX LEVANTE

Avenida Zodiaco, 3
03006 Alicante
Alicante

Tel: 965 401 548

levante@ironlux.com



SOLICITUD DE PRESUPUESTOS
ofertas@ironlux.com

SOLICITUD PEDIDOS
pedidos@ironlux.com

CONTABILIDAD
contabilidad@ironlux.com

INCIDENCIAS
reclamaciones@ironlux.com

CERTIFICADOS Y FICHAS TÉCNICAS
calidad@ironlux.com

IRONLUX
GROUP